

ACCESSORIES FOR EPDM PLAYGROUNDS

FOR WET POUR INSTALLERS
AND PLAYGROUND DESIGNERS

4soft

EASIER
FASTER
PERFECT
EFFECTIVE

**WELCOME TO
THE KINGDOM OF CHILDREN'S IMAGINATION**



WE HELP YOU TO CREATE GREAT PLAYGROUNDS

With :

- 2D EPDM graphic component.
- 3D EPDM graphic components.
- Special play equipment and accessories for your playgrounds.
- Inspiration from our creations.
- Playground plan incorporating your ideas.

CATALOGUE INDEX:

- 04-07** 4soft solution
- 08-13** 2D graphic components
- 14-19** 3D graphic components
- 20-25** Water fountains
- 26-31** Tunnels (standard, modular)
- 32-33** Funpipe Smart
- 34-35** 3D EPDM Playhouse
- 36-37** Mini arena
- 38-39** Sports arena
- 40-44** EPDM Bench-Play
- 45** EPDM Waste Bin-Play
- 46-49** Humpy Bumpy
- 50** Logos and special design
- 51** EPDM panelling



- 52-59** Splash areas
- 60-63** Playgrounds in public parks and gardens
- 64-67** For schools and kindergartens
- 68-75** Heavy-duty playgrounds
- 76-79** Multipurpose playgrounds
- 80-83** Traffic playgrounds
- 84-85** Rest areas and meeting places
- 86-89** Multi-purpose areas for game & sport
- 90-99** Sportsgrounds
- 100-105** Trampoline playgrounds
- 106-109** Safe pavements and terraces
- 110-111** Fitness and workout
- 112-115** 3D sandpits
- 116-137** List of 2D/3D graphics
- 138** Beware of low-quality
- 139** Packing of the graphic components
- 140** Basic colours of components



4SOFT OFFERS ORIGINAL SOLUTIONS FOR YOUR PROJECTS

4SOFT COMPANY

12 years of experience in manufacturing EPDM graphic components.

Offer of more than 2500 prefabricated 2D and 3D graphic components made from EPDM.

Cooperation with more than 160 wet pour installation companies in 32 countries all over the world.

Only high-quality products used.



WE HELP YOU TO CREATE PLAYGROUNDS NICER & FASTER, THAN OTHERS!

KEY BENEFITS

1. FAST

2. EASY

3. EFFECTIVE

4. PERFECT

You can find out more about our products at:
epdm-graphics.com

4SOFT 2D AND 3D GRAPHIC COMPONENTS

The most effective way of creating an interesting EPDM surface.



4soft products can be used on any EPDM wet pour surface.

Our graphics make the playground areas:

- more attractive and fun,
- provide added value,
- minimise the risk of warranty claims.



OUR PRODUCTS ARE MADE FROM HIGH-QUALITY EPDM AND POLYURETHANE BINDER.

SLOW, DIFFICULT, EXPENSIVE, BAD...



TO INSTALL MULTI-COLOURED GRAPHICS ON EPDM WET POUR SURFACES YOU NORMALLY NEED:

- a lot of time to shape the graphics to the form needed;
- to wait for each colour to cure before you can start with the next one;
- to prepare templates;
- to have workers skilled in art on the site;
- more time (more days) to finish the surface.

SLOW SOLUTION



FAST, EASY, EFFECTIVE, PERFECT



HOWEVER, THERE IS ALSO A MORE EFFECTIVE WAY OF CREATING AN INTERESTING WET POUR SURFACE

- + create a more attractive (more competitive) wet pour surface;
- + install all component on the top surface layer easily and quickly in just one day;
- + save labour costs and material;
- + make it without needing workers skilled in art in your installation team;
- + finish the project much more quickly and cheaply.

FAST SOLUTION





2D GRAPHIC COMPONENTS

Bee
C5-05A-52UV

Rainbow
D5-02A-70UV

Set of stones A-Z
D4-05A-20

Cloud
D5-04A-55UV

Duck
C3-01A-52UV

Flower-2
D2-01A-57UV

Cloud
D5-04A-55UV

Tunnel
T2-01A

3D Flower
L5-01A-09

Crocodile(1-10)
F6-02A-53UV

3D Ant hill
L3-01A-20

Ant
C2-01C-01

Splash & 3 drops
H2-01A-00

2D GRAPHIC COMPONENTS

Choose the right EPDM graphic component & glue it !

BE MUCH FASTER AND MORE EFFECTIVE

Each detail is made from EPDM granules without any additional surface painting.



JUST GLUE IT!

SMART EDGE



Specially shaped, no cutting, with oblique EDGES 45° angle which means perfect adhesion of the EPDM wet pour surface around the graphics as well as stable and durable joins.

SMART EDGE means NO CRACKS inside the EPDM graphic components (we do not use knives or water jet cutting).

ALL IN ONE WORKING DAY GRAPHICS AND SURFACE !!!

WE ARE CONSTANTLY WORKING ON IMPROVEMENTS!

This is a hand-made product not fabricated on a pressing machine. The reason is simple! Prefabricated graphics looks the same as the rest of the EPDM surface.



4SOFT 2D WET POUR GRAPHICS ARE 10 MM THICK.

FOR UV SENSITIVE COLOURS, WE USE ALIPHATIC BINDER.



STABLE AND DURABLE JOINS!



NO CRACKS!
(around components)

INSTALLATION GUIDES

For 2D EPDM graphics.

Just glue the graphic component on to the SBR layer or directly on concrete. Take a look at our simple installation guides.

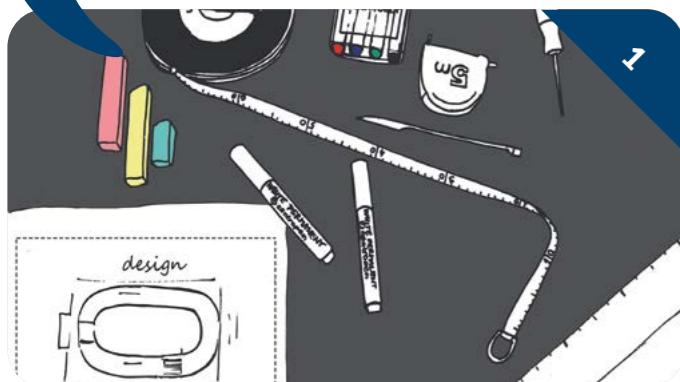

Tools needed to measure the required graphic and the material for gluing.



Measure and copy the graphic on a cured SBR layer along with the required design.



Mix the two-component glue properly. Use standard PU glue for artificial grass. Use the two-component glue for larger patterns or more graphics.



Spread the glue evenly on the underside of your graphic.

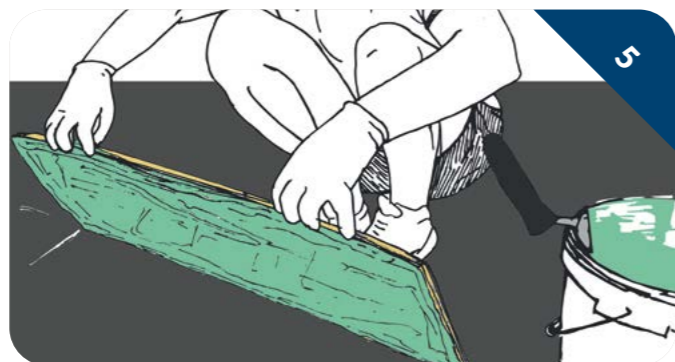

Make sure the glue is spread evenly and up to the edges !!!

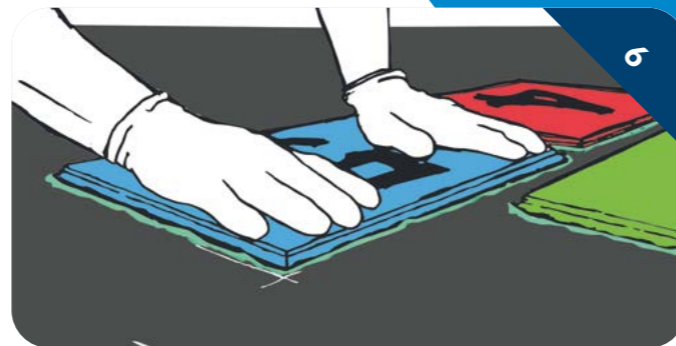

Position the graphic exactly and press it properly to improve glue distribution.

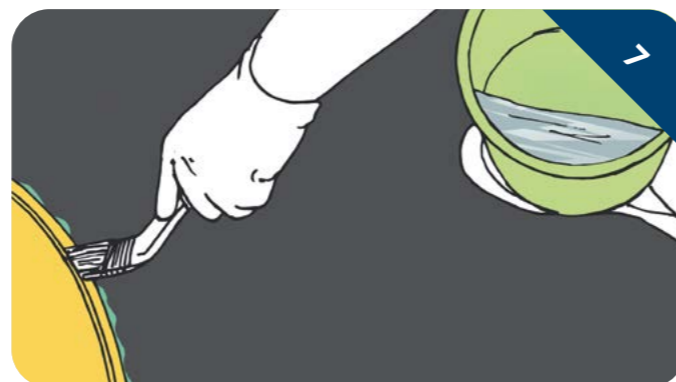

Apply the thick binder on the outside edges of the component to avoid them separating from the rest of the EPDM on the top layer.



Spread and compress your final EPDM layer properly around the component.

MAKE A SUPERB SURFACE!

CHOOSE THE RIGHT GRAPHIC COMPONENTS & GLUE THEM



There are many ways of using our 2D graphics to transform a dull EPDM surface into an entertaining and educational place.

ALL YOU NEED TO DO IS JUST CHOOSE THE RIGHT GRAPHIC COMPONENTS AND GLUE THEM.

The rest of the surface installation is then very simple.

3D Sea star
K1-02A-09

Order, measure, glue and finish the surface around it. Easy :)

3D GRAPHIC COMPONENTS

Simple and fast installation with a great result!

JUST
GLUE IT!

3D GRAPHIC COMPONENTS

- ATTRACTIVE ELEMENTS
- PERFECT DURABILITY
- SAFE PLAY
- FAST INSTALLATION

Our 3D graphic elements are certified according to EN 1176-1 standards by TÜV authorities.

You can find out more about our products at:
epdm-graphics.com



Play elements in many ways – soft seats or just safe decorations for playgrounds.

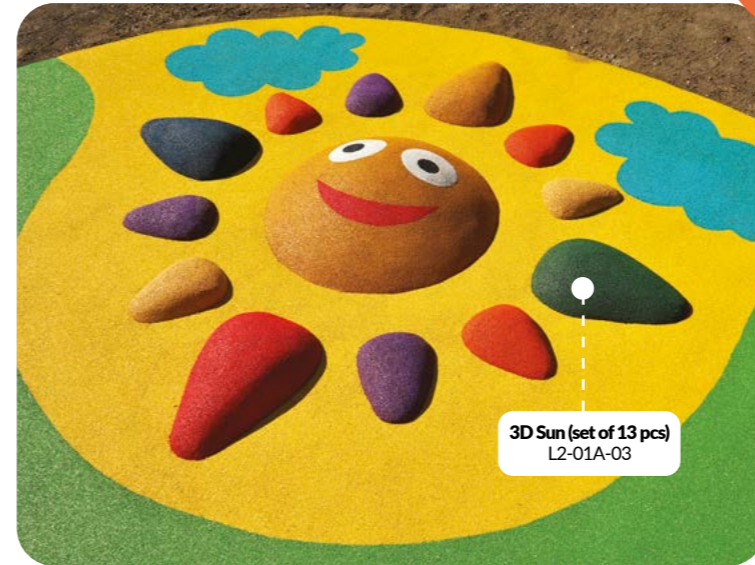

To achieve a great result, combine 3D shapes with standard 2D graphics.



4soft 3D graphics are made only from SBR on the inside and high-quality EPDM on the outside.

Each detail is made from EPDM granules without any additional surface painting.

Children just love them!

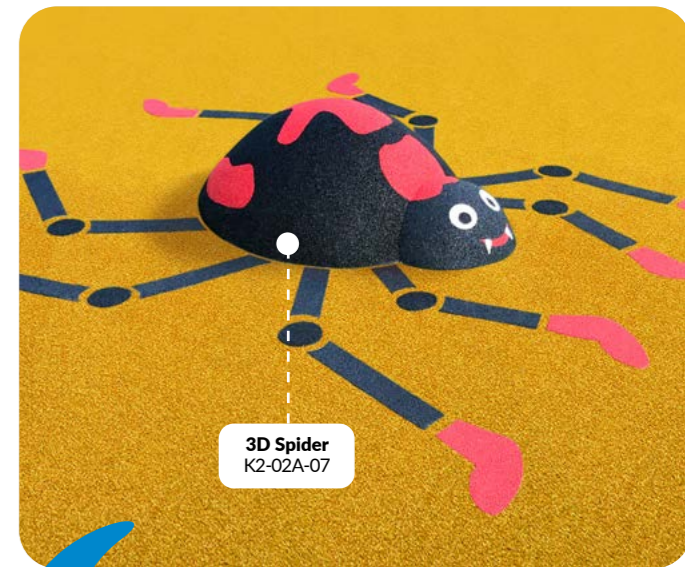

More fun for kids than you think !

DO A FASTER & NEATER JOB!

INSTALLATION:

- just glue it onto the SBR layer;
- weight depends on size - from 10 kg to 180 kg;
- can also be installed on artificial turf, rubber tiles or concrete sub base.

You can find out more about our products at : epdm-graphics.com

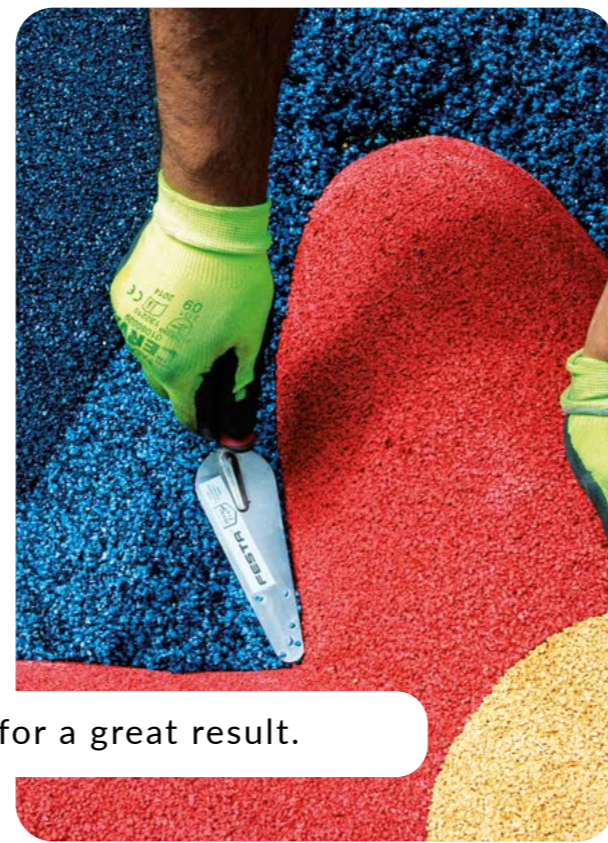

Simple and fast installation for a great result.



Copy the graphic on the SBR layer along with the required design.



Apply the thick binder on the outside edges of the 3D component to avoid them separating from the rest of the EPDM on the top layer.



Position one or two components and glue them directly onto the SBR - be careful about the upper side of the component to avoid staining it with the binder!



Screed and compress your final EPDM layer a round your 3D component. Cartridges or tubes. For ex-ample, Proline T44 or Extrem FIX.



Position the 3D component and press it properly to improve glue distribution.

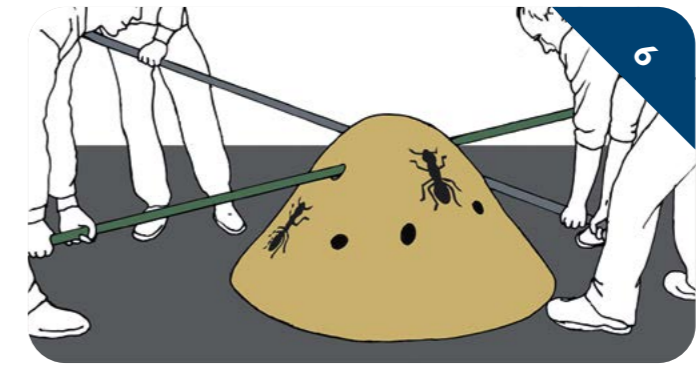

To transport the heavy 3D anthill, use two iron bars and pass them through the holes.

INSTALLATION GUIDES

For 3D EPDM graphics by 4soft.

Working with 3d graphics is very easy. Just glue them !



To transport the heavy 3D ladybird or 3D turtle, we install two belts directly on them to make handling easier.



You can use two iron bars to attach the belts to the components. After gluing the 3D objects, the belts can be cut away or just pulled out.

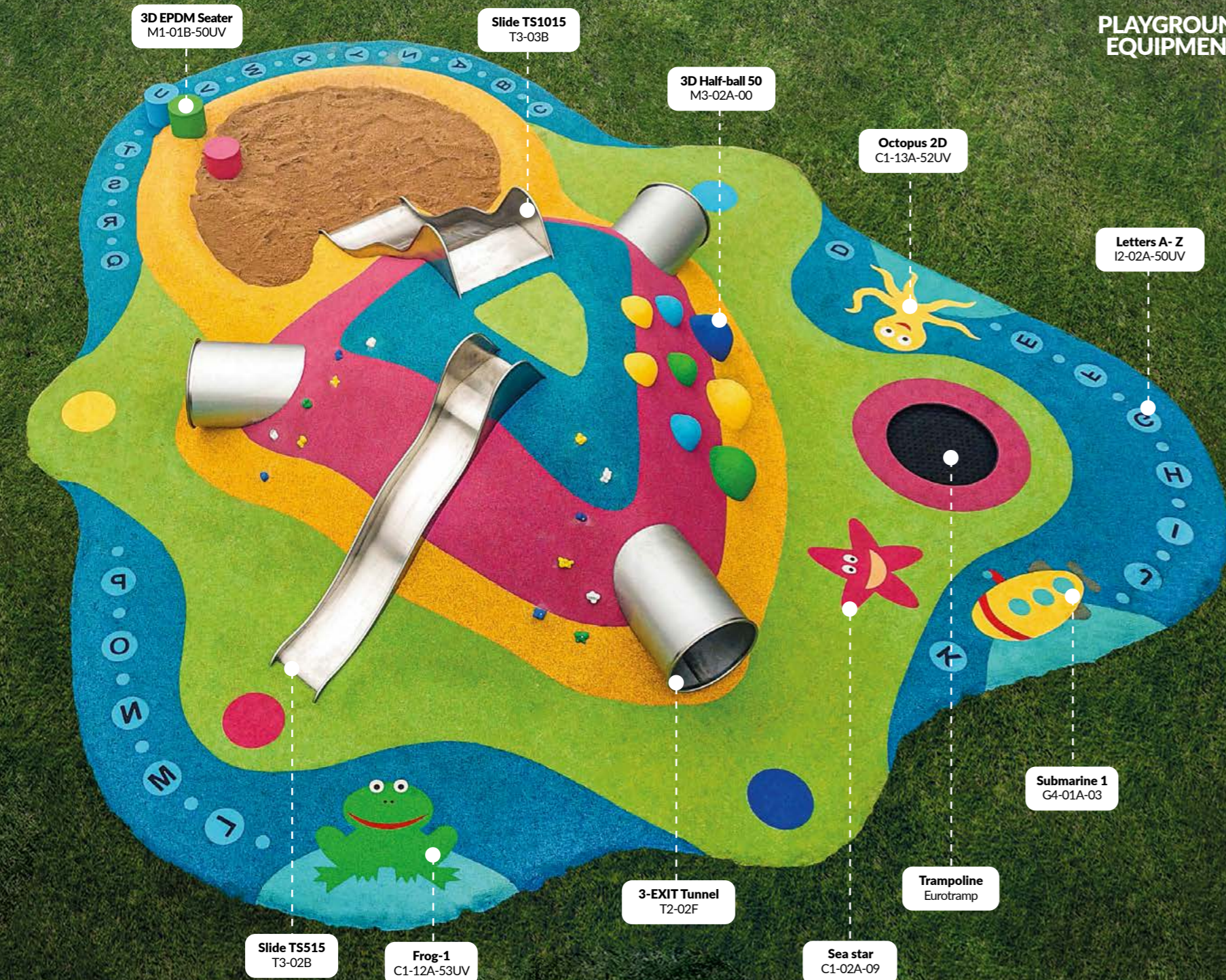

OTHER PLAYGROUND EQUIPMENT

“ Multiply the play potential of your new projects ”

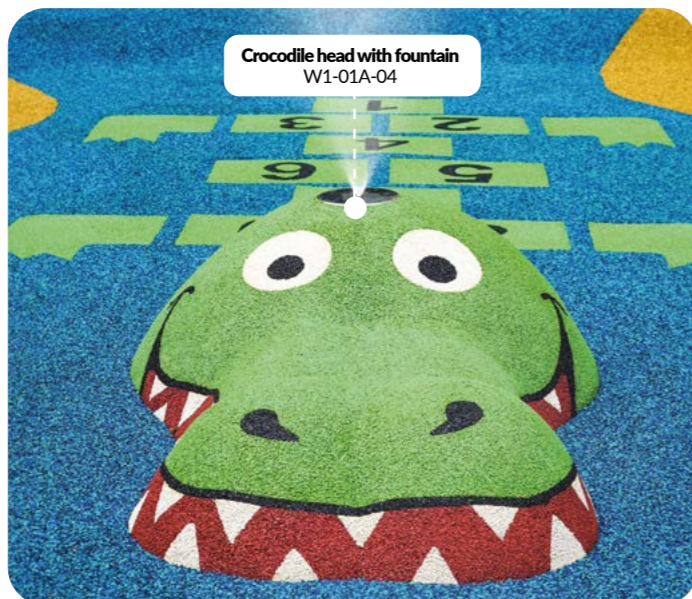
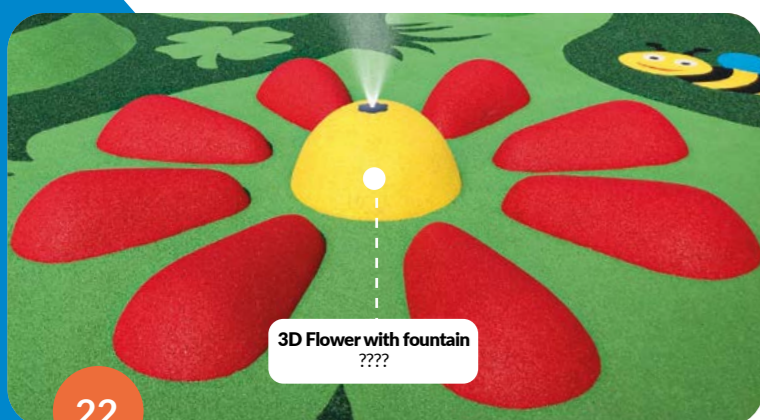
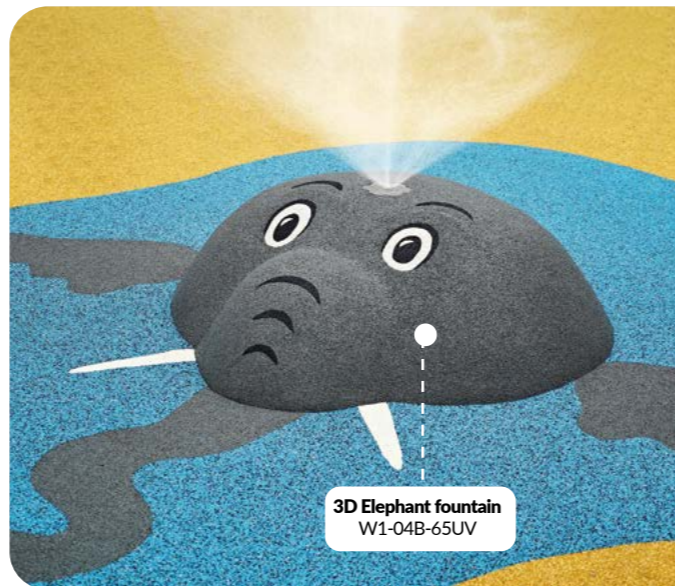
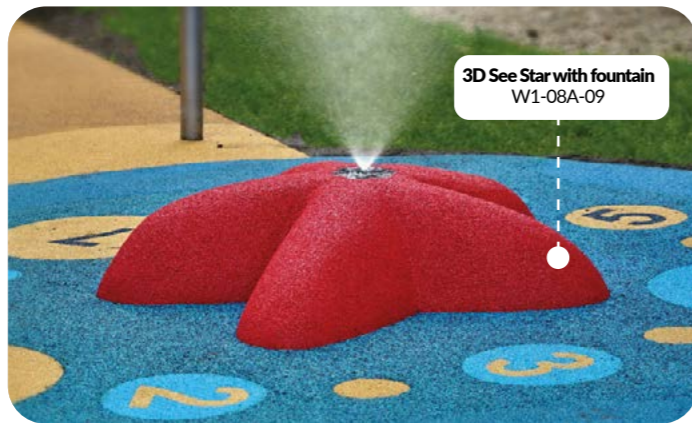
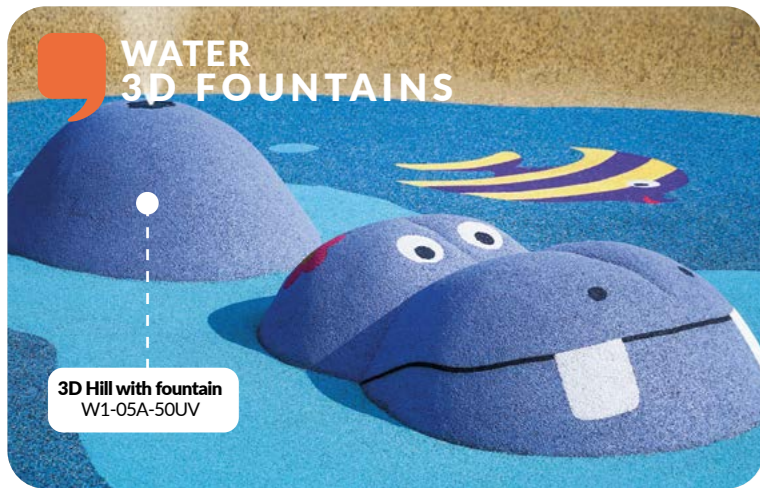

WATER 3D FOUNTAINS

A combination of 3d graphics and splash areas is great in the summer time.

A water nozzle can be installed into any 3D shape according to your requirements.

Water fountains can be a part of standard playgrounds.

IDEAL SOLUTION FOR:

- kindergartens;
- schools;
- public areas and parks;
- public playgrounds;
- swimming pools.

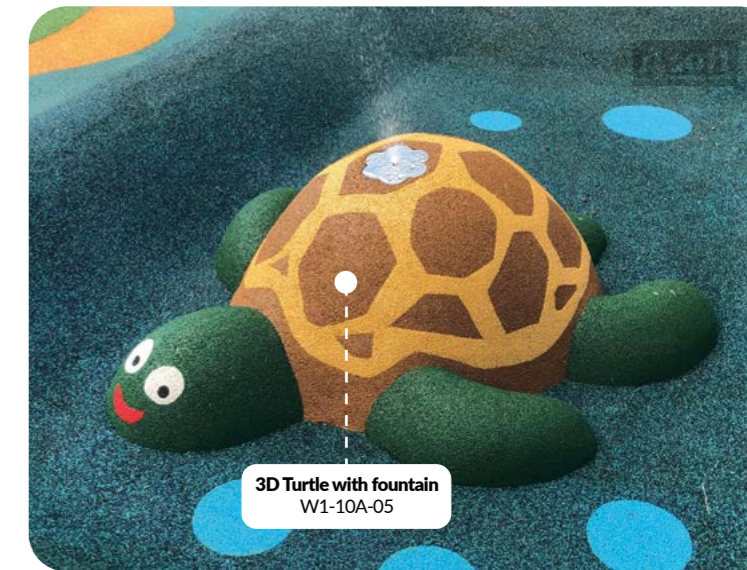

You can find out more about our products at : www.epdm-graphics.com

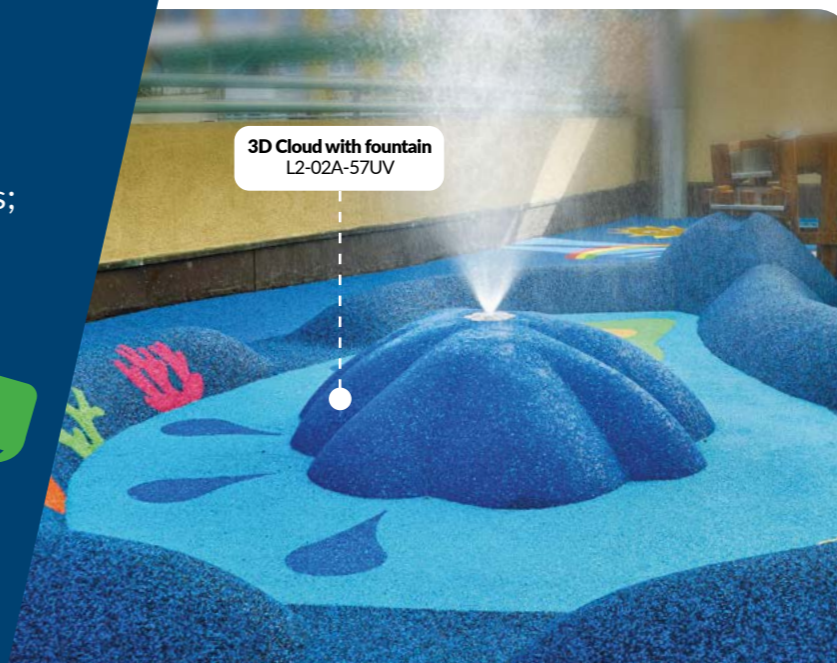



WATER FOUNTAINS TECHNICAL INFORMATION

Easy to connect to the water supply!

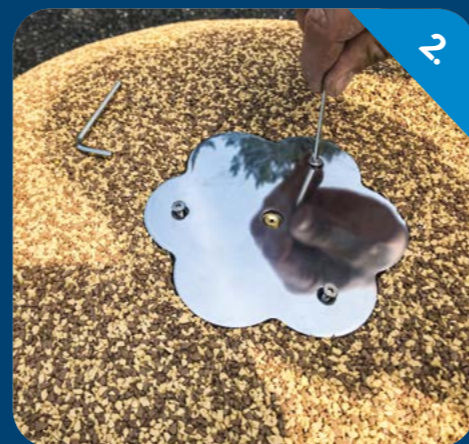
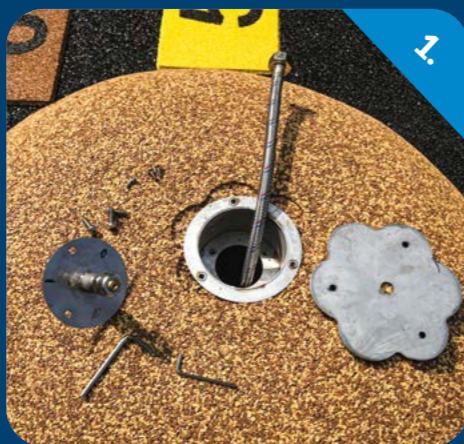

ALL YOU NEED IS A STANDARD
WATER GARDEN CONNECTION
WITH NORMAL PRESSURE!

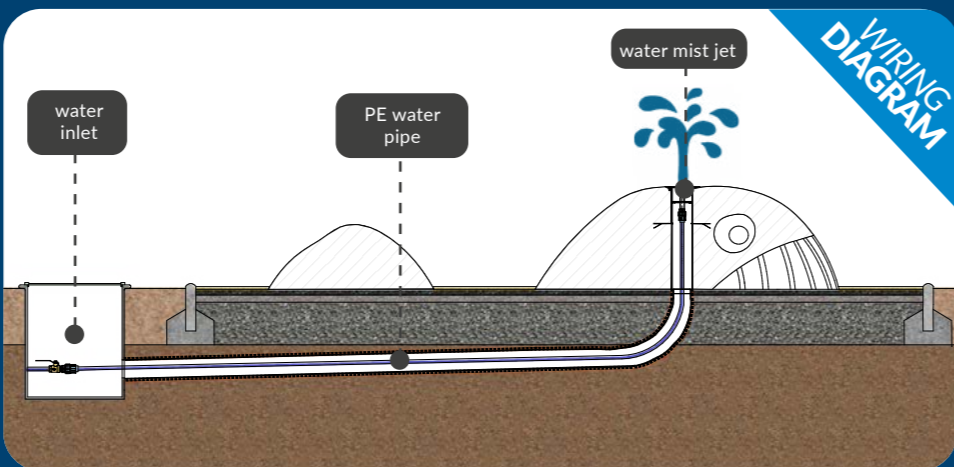

OPERATING THE NOZZLE

There are two options of controlling the opening and closing the water connection to the fountain:

- a standard water valve;
- electric button – possibility to set up the duration of water squirting. It works with a 6V battery.



LOW WATER CONSUMPTION

Water consumption depends on the selected nozzle, from 2.5 l/min to 6 l/min.

One water supply can be connected to more nozzles depending on the flow rate of the water connection.



NO PUMP

All you need is a standard water supply with a pressure of 2-3 bar.

You can find out more about fountains at: www.epdm-graphics.com

GREAT
FUN
FRESH
SAFE



Length 1200 mm
Diameter 510 mm
Height approx. 650 mm.



EXTREMELY DURABLE TUNNELS MADE OF STAINLESS STEEL.



4SOFT MINI TUNNELS

For safe surface areas.

Very popular play equipment with many design variations.

It can be modified according to your request.

Supplied directly with the EPDM surface.

Certified according to EN 1176-1 standards.

LITTLE HILL = LOTS OF FUN!

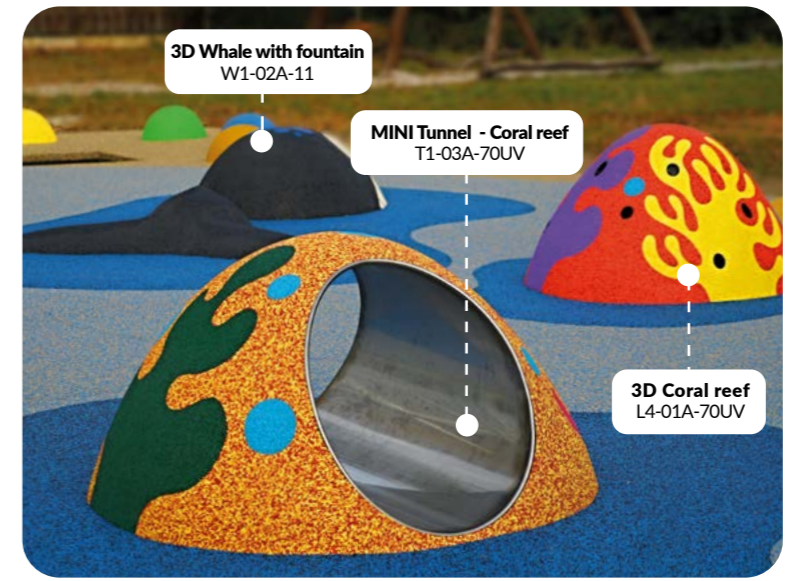

Simple and fast installation with a great result.
Just Glue It.

DURABLE & SAFE



STANDARD BUILT-IN TUNNELS

Designed to be built into a concrete hill and covered by an EPDM safety surface.

Made from stainless steel.

Perfect when combine with slides and climbing elements.

TÜV certification EN 1176-1.



CAN BE USED IN MANY GREAT WAYS! SIMPLE TO INSTALL.

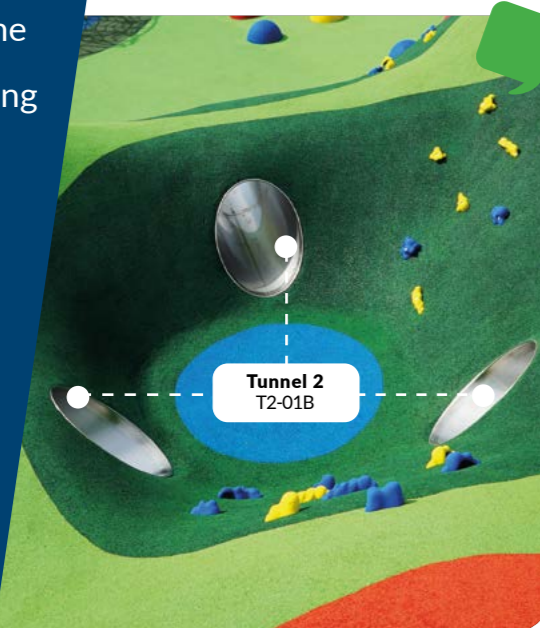

MAKE YOUR PLAYGROUND MORE ATTRACTIVE, THAN OTHERS. WITH 4SOFT TUNNELS

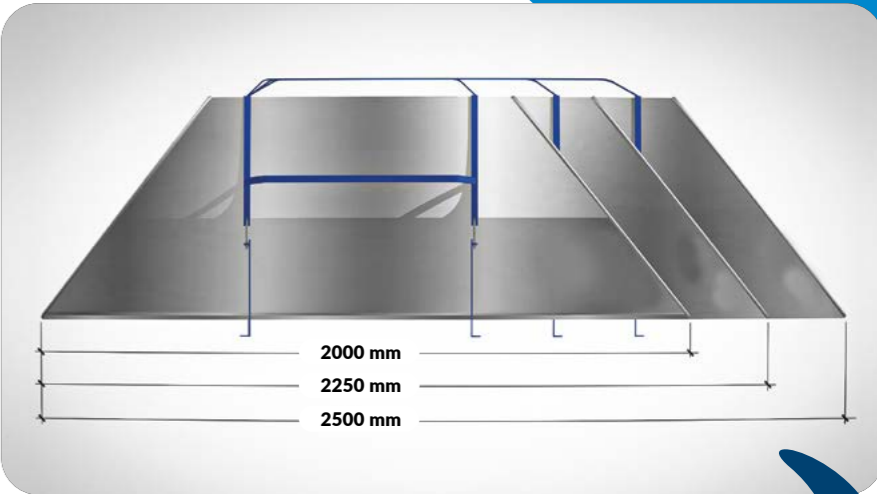
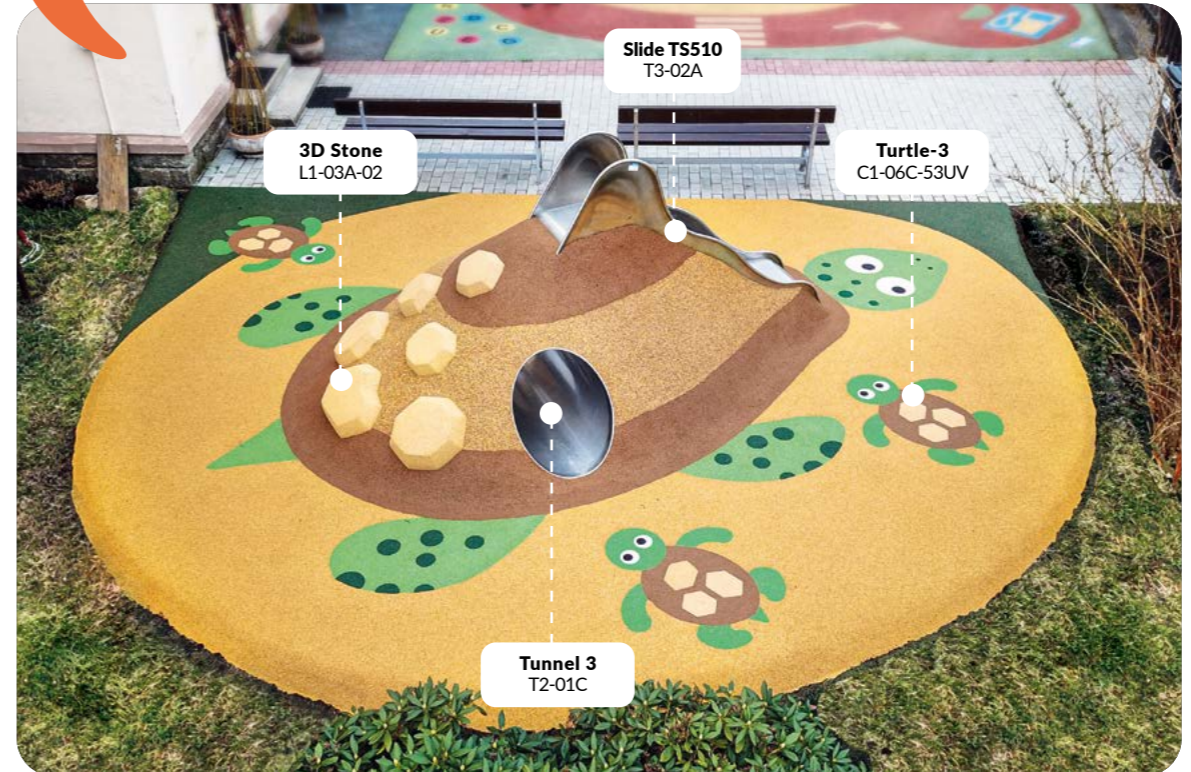

The **DIAMETER** of these tunnels is 650 MM. **LENGTH OF THE BOTTOM PART.**
 Type 1, 2000mm
 Type 2, 2250mm
 Type 3, 2500mm.



MODULAR BUILT-IN TUNNELS

4soft has developed modular stainless steel tunnels, certified by TÜV authorities, to be built into a concrete hill and covered by an EPDM safety surface.

All types of the modular tunnel are available in short and long version.

You can find out more about modular tunnels at : epdm-graphics.com

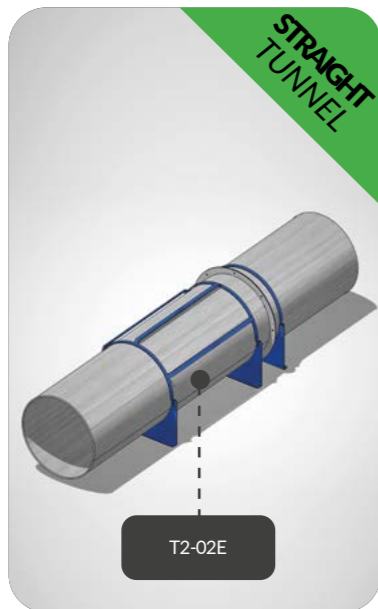

DESIGNED FOR THE SPECIFIC SHAPE OF A 3D HILL.

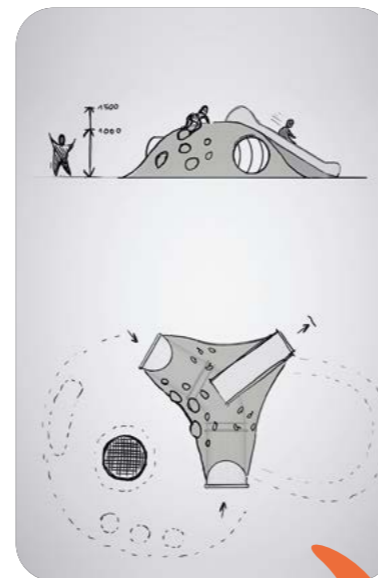
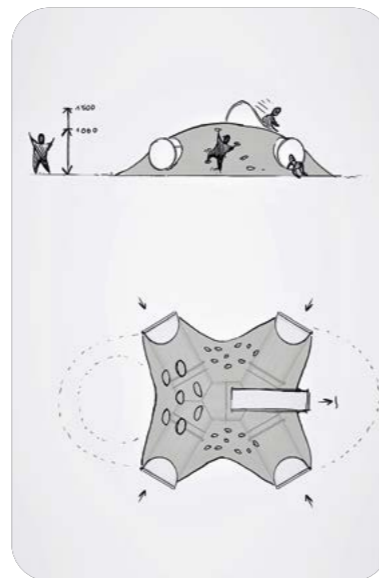
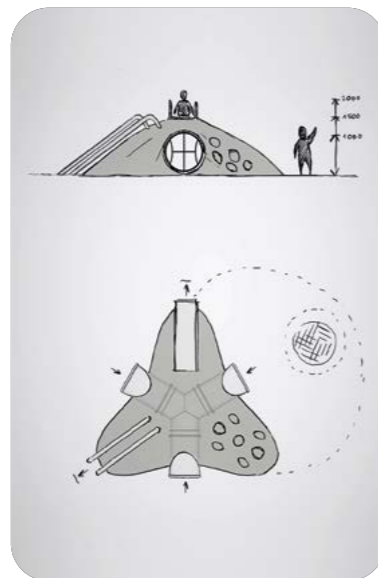
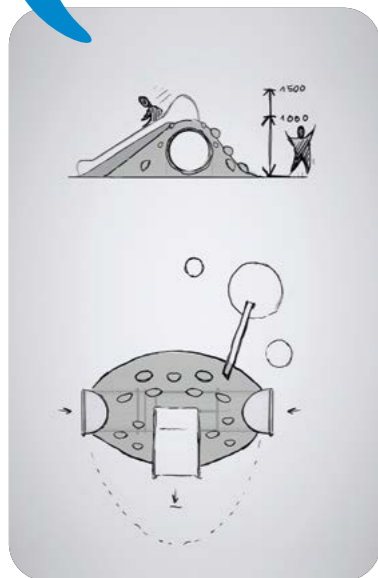

DESIGNED FOR EXTRAORDINARY PLAYGROUNDS!



LOT OF FUN WITH ONE HILL





FUNPIPE SMART

FunPipe SMART - Long
T3-01A-FPL (450 cm)

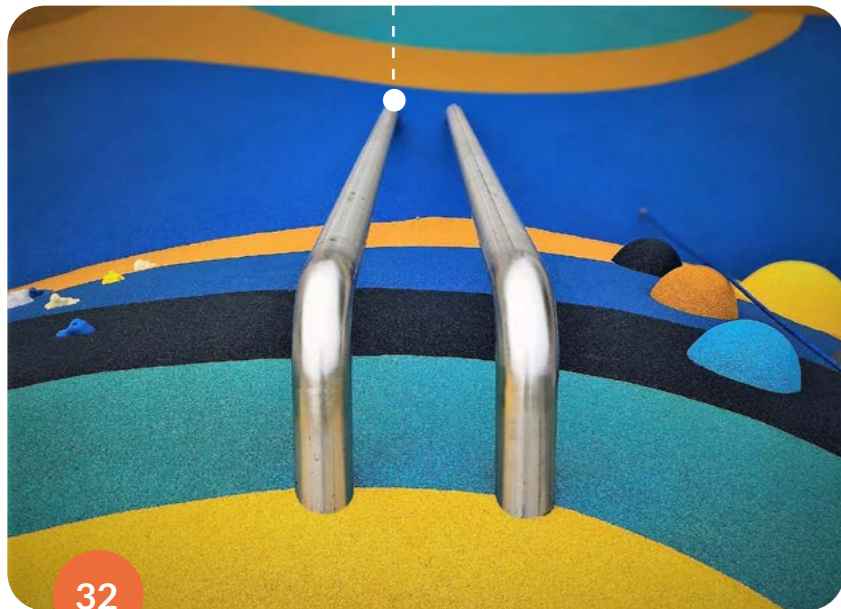

2D Apple
D3-03A-09

2D Snail
C5-04A-02

FunPipe SMART - Small
T3-01B-FPS (230cm)

Slide TS510
T3-02A

FUNPIPE SMART

Simple and heavy-duty play equipment.

Length - 2300-4800mm
Height of hill 1000 or 2500mm.

Certified by TÜV according to EN1176-1.

Superb when combined with tunnels, standard slide and 3D EPDM graphics.



DESIGNED FOR SLOPES

FIREMAN'S SLIDE :)

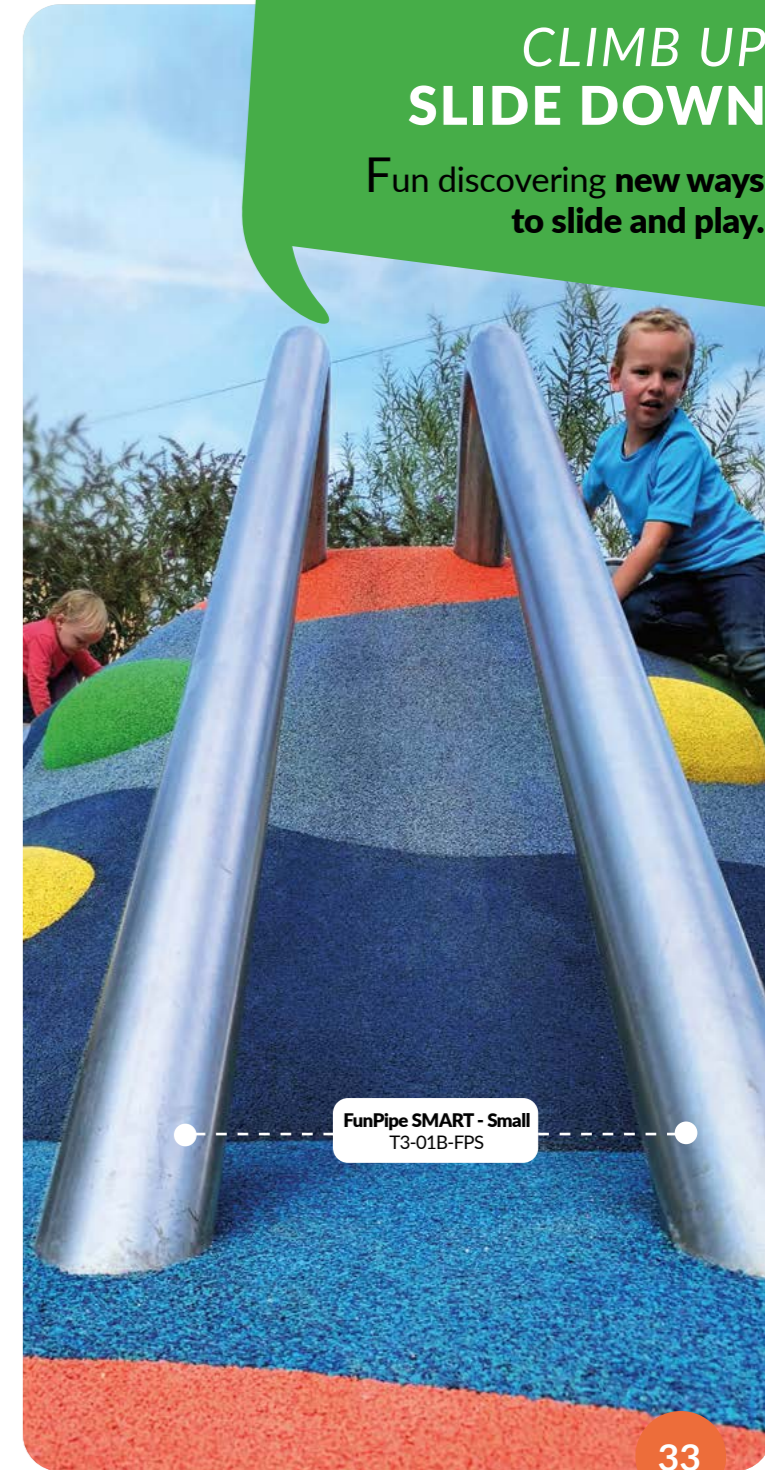

CLIMB UP SLIDE DOWN

Fun discovering new ways to slide and play.

FunPipe SMART - Small
T3-01B-FPS

3D EPDM PLAYHOUSE

Fun play element for playgrounds with an EPDM surface.

Consists of a stainless steel core, covered with a certified two-layer safety surface.

Can be used separately as a single element or as a part of a complete playground.

Certified according to EN 1176-1



Can be climbed over and used as a climbing wall. Its surface is fitted with grips enabling easier movement over it.

IT CAN BE MADE IN OTHER THEME-SPECIFIC VERSIONS

A small UNBREAKABLE window.





MINI ARENA

MINI Arena V5-02A

Hopscotch Small-boy F1-03A-00

MINI ARENA

Smart and economical solution.

Fun kindergarten playground.

Made for ball games and other exercises.

Perimeter and integrated goals multiply game use.

Boarding can be provided with markings to your requirements.

You can find out more about modular tunnels at: www.epdm-graphics.com

The mini-goal can also be used on its own, without boundaries.

THE INTEGRATED GOAL CAN ALSO BE USED AS A BENCH FOR SMALL PLAYERS.



MINI Arena V5-02A



MINI Arena V5-02A



MINI ARENA

MINI Arena V5-02A

Circel with number A1-13Z-00

Human footprint B3-01A-07

INTRODUCING NEW MINI ARENAS!

4soft can provide you with complete design drawings of required mini-arena along with what you desire.





SPORTS ARENA

Smart vandal-proof sports equipment for schoolyards, parks and other places.

The combination of Sports Arena with 4soft EPDM graphic components creates an interesting place full of activities.

It is constructed of galvanized steel.

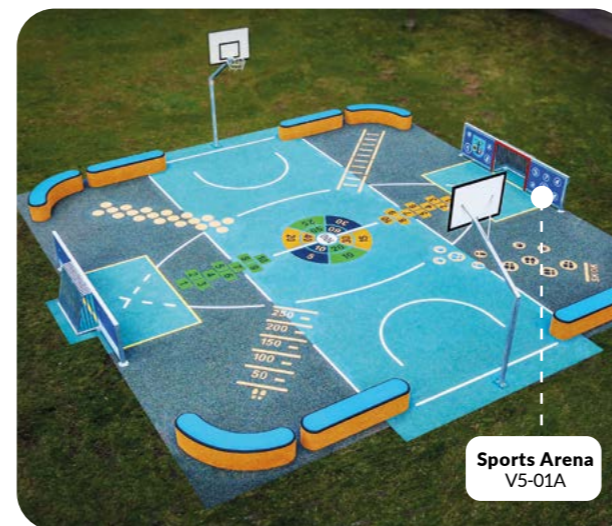

4soft can provide you with complete design drawings of the required Sports Arena playground along what you desire. Just send us a request.



Choose from four boarding colours (red, yellow, green, blue) Made from durable HDPE.



Part of goal boarding can be also used as a drawing board.



GREAT EFFECT IN A SMALL SPACE!

EPDM BENCH-PLAY

This extra-ordinary and safe bench made from EPDM can be used in many ways and comes in many variations.

GREAT EQUIPMENT FOR:

- playgrounds;
- schools and kindergartens;
- parks;
- outdoor fitness areas;
- sports grounds.

IT SERVES AS:

- safe and durable bench;
- play or exercise equipment;
- useful decoration;
- advertising poster.



THREE BASIC TYPES / MODELS:

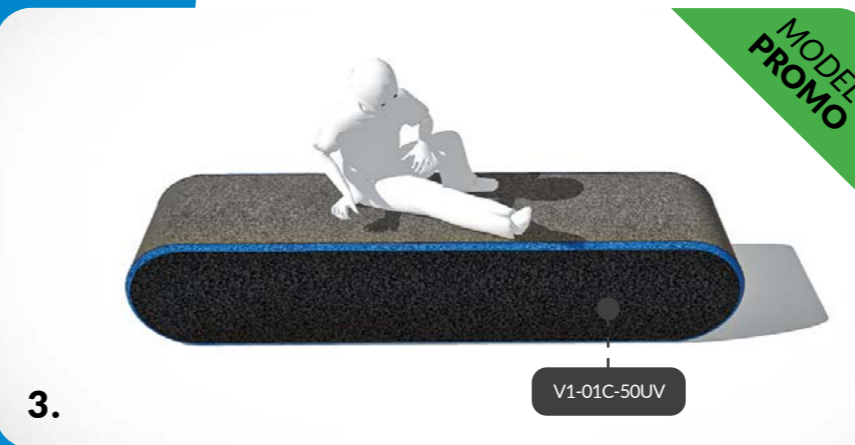
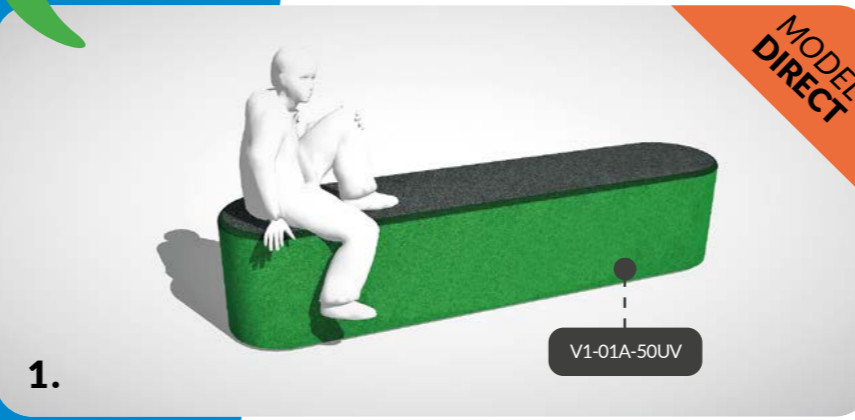

Good meeting place and useful rest area for players and spectators.



100+1 BENCH DESIGNS

Bench as a dominant element of your playground.

SIT OR PLAY!

Certified according to EN 1176-1

The bench with the palisade forms a set with a table.

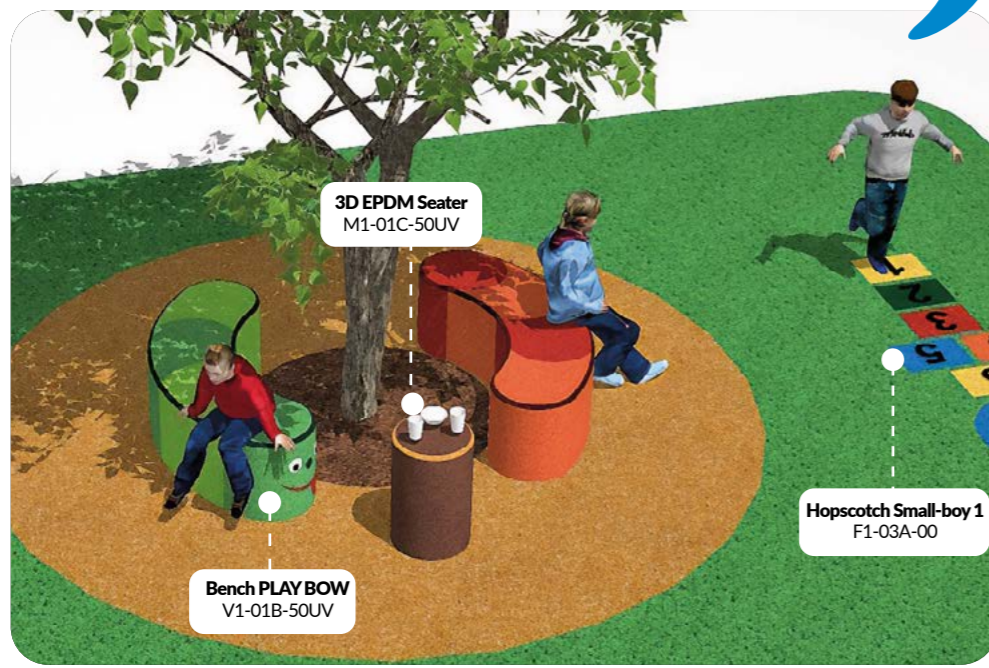

3D EPDM Seater M1-01C-50UV

Bench PLAY BOW V1-01B-50UV

Hopscotch Small-boy 1 F1-03A-00

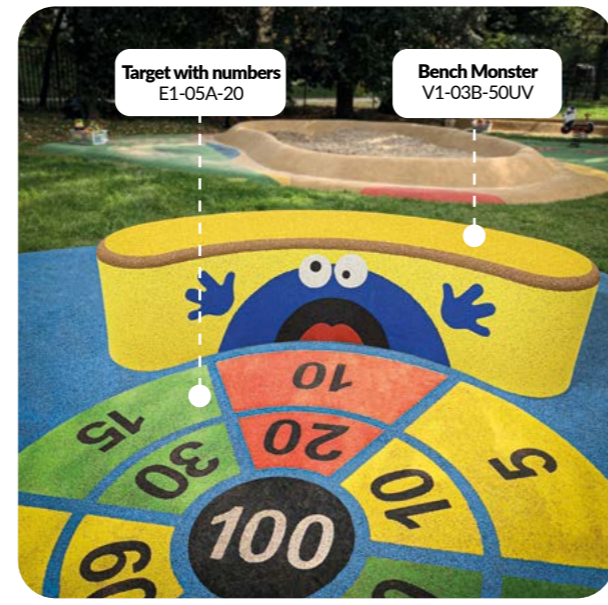

Target with numbers E1-05A-20

Bench Monster V1-03B-50UV

4soft can help you design your required place.



Bench PLAY - Dragonfly -

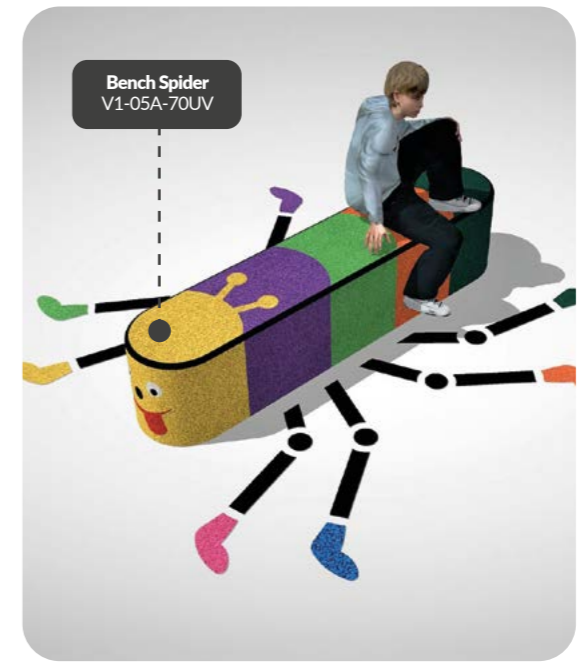

Bench Spider V1-05A-70UV

There's no bench like a bench. It can be more than that!

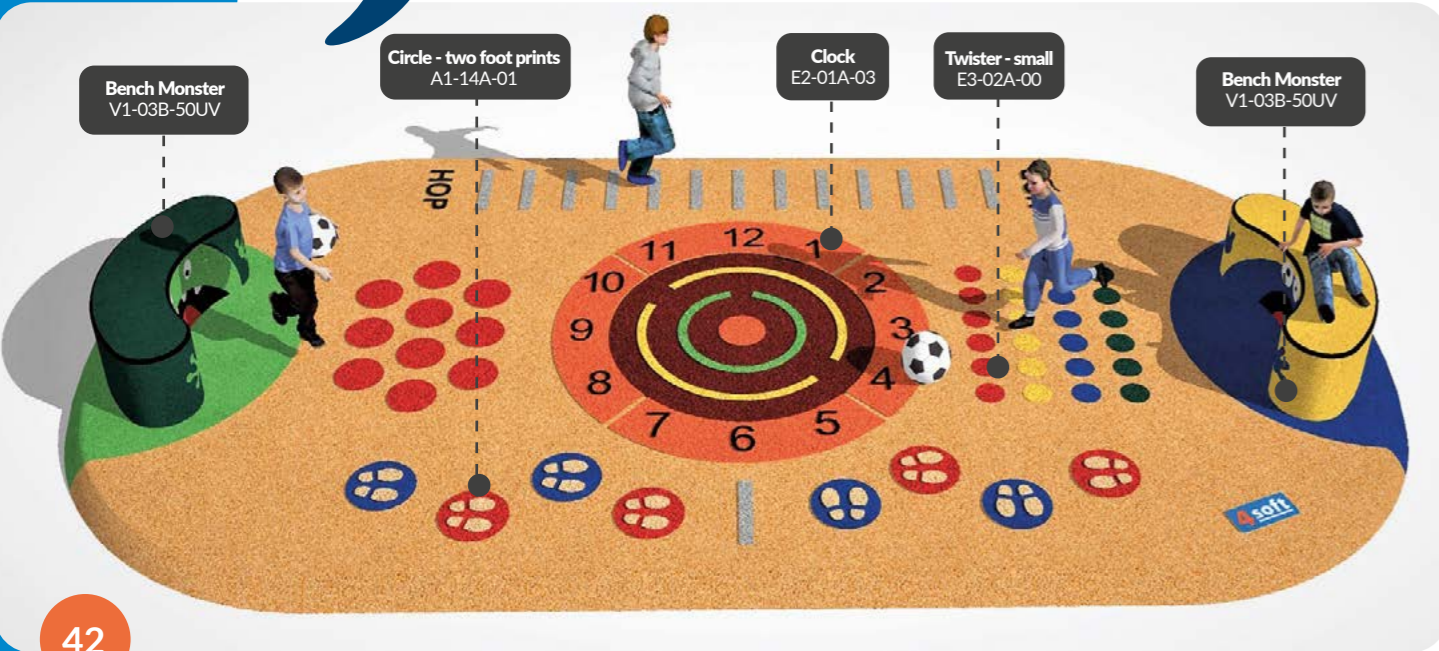

Bench Monster V1-03B-50UV

Circle - two foot prints A1-14A-01

Clock E2-01A-03

Twister - small E3-02A-00

Bench Monster V1-03B-50UV

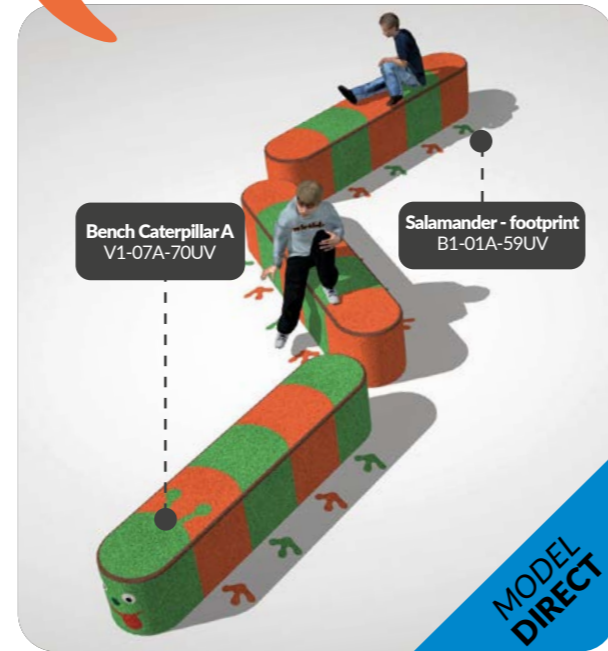

Bench Caterpillar A V1-07A-70UV

Salamander - footprint B1-01A-59UV

MODEL DIRECT

COMPLETE YOUR PLAYGROUND WITH BENCH PLAY

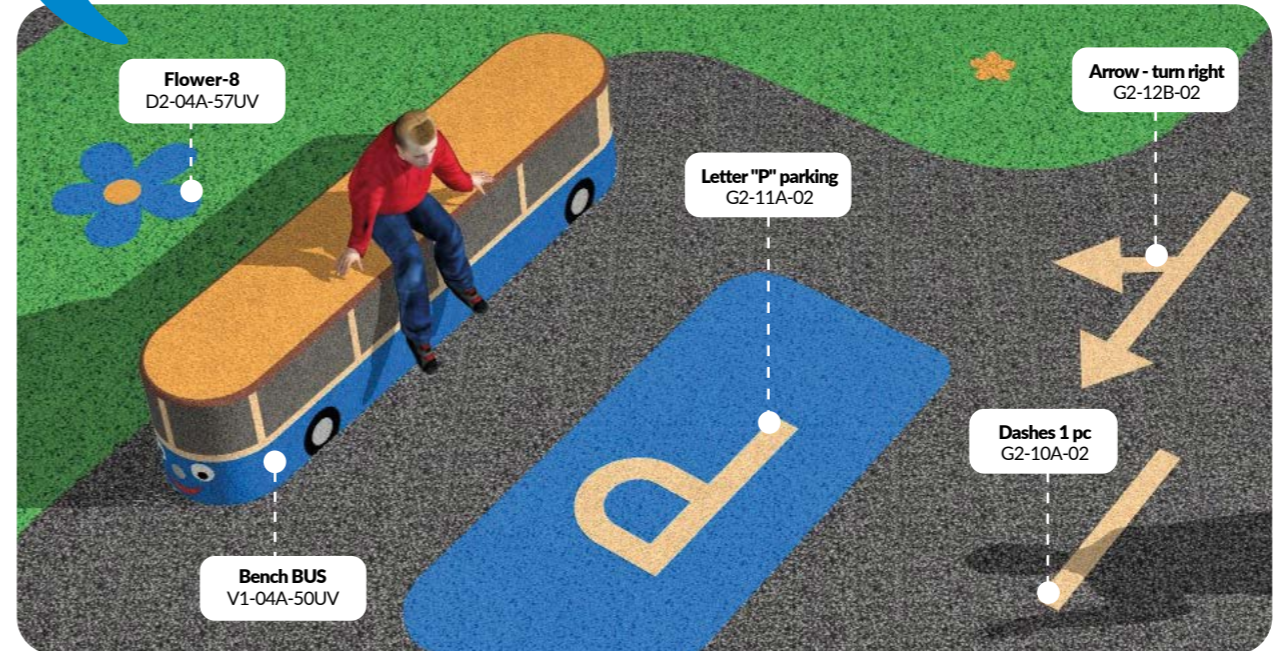

Flower-8 D2-04A-57UV

Letter "P" parking G2-11A-02

Arrow - turn right G2-12B-02

Bench BUS V1-04A-50UV

Dashes 1 pc G2-10A-02

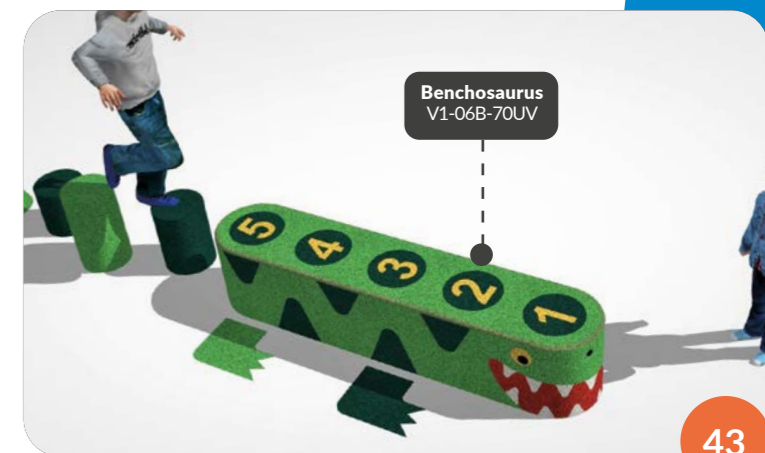

Benchosaurus V1-06B-70UV

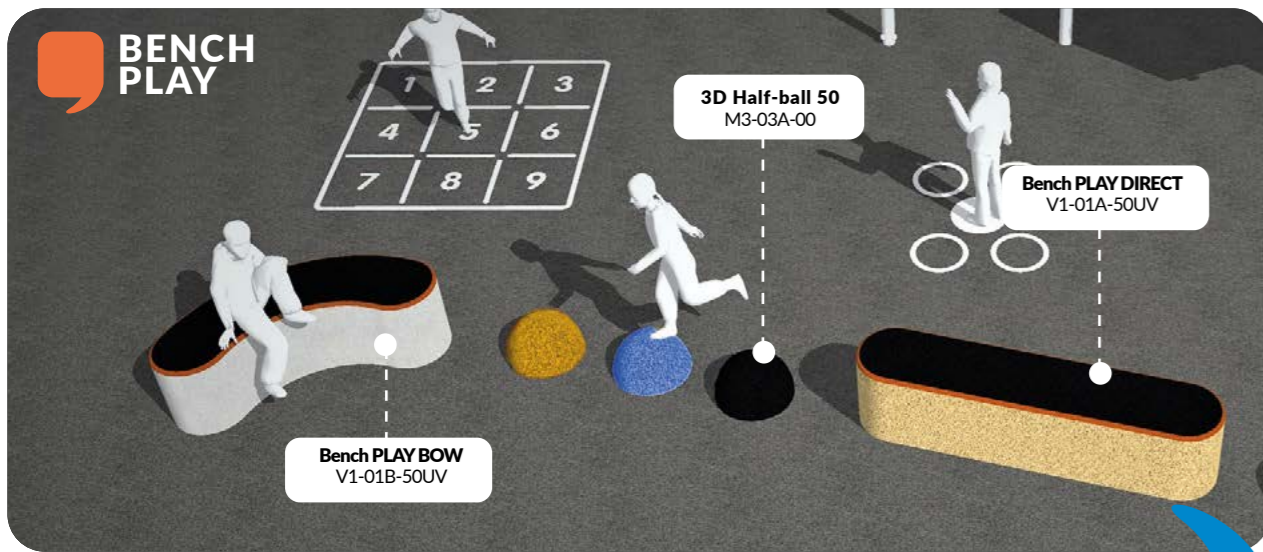

Our benches can be designed to clients' requirements.

Combining EPDM benches and other 3D graphics components (such as hemisphere, seaters, etc.) can create a practical and attractive part of workout and fitness playgrounds.

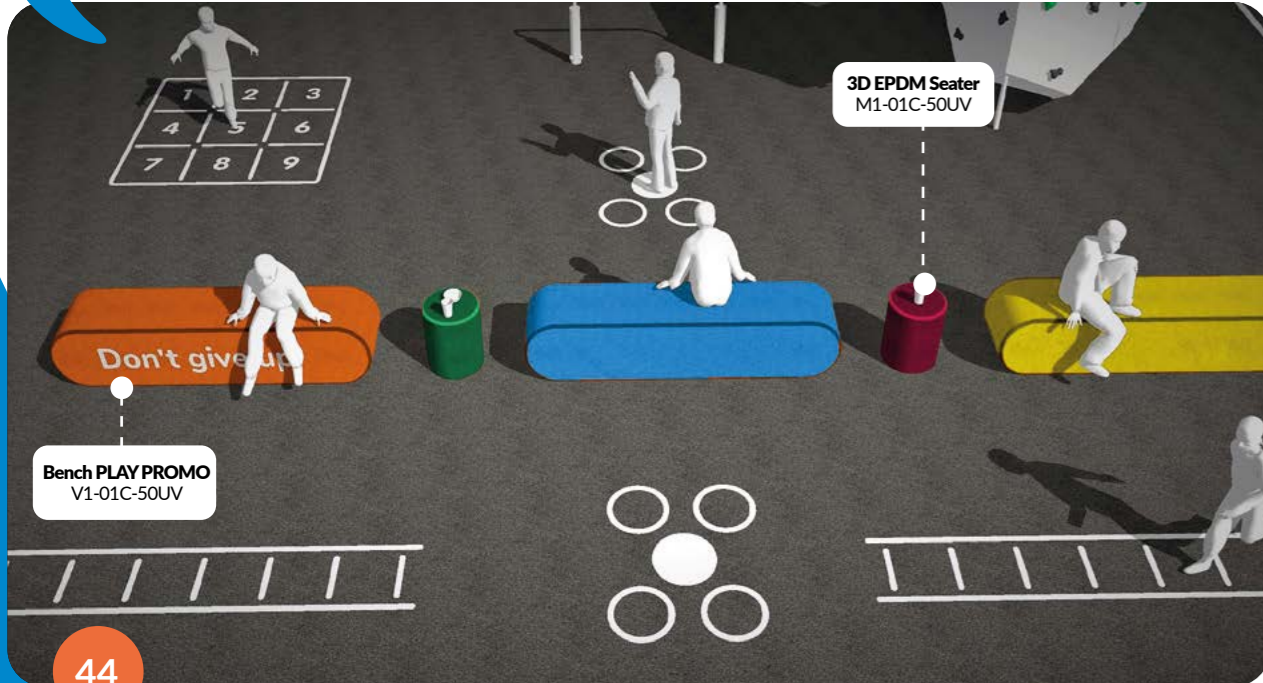

EPDM WASTE BIN-PLAY

Essential equipment to keep playgrounds clean and tidy.
Compatible with EPDM surface and play equipment.



DURABLE
Galvanized steel construction covered with EPDM.

PRACTICAL
Simple opening and cleaning system.
Three containers for sorted waste.

GRAPHICAL
Choose from several colours and designs for the required place.

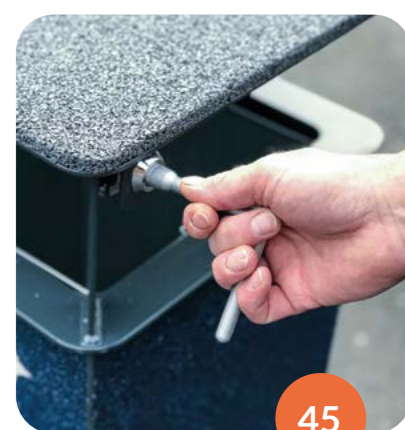

FUN!

HUMPY BUMPY

Mobile playground element designed to develop general motor skills, skilfulness, balance and strength in children.



Humpy-bumpy 30
V3-01B-00

Humpy-bumpy 50
V3-01B-00

FOR OUTSIDE & INDOOR USE



Humpy-bumpy Turtle
V3-03B-70UV



PLAY



LEARN

Humpy-bumpy LadyBird
V3-02A-70UV

Every time a different game, but still at the same place.

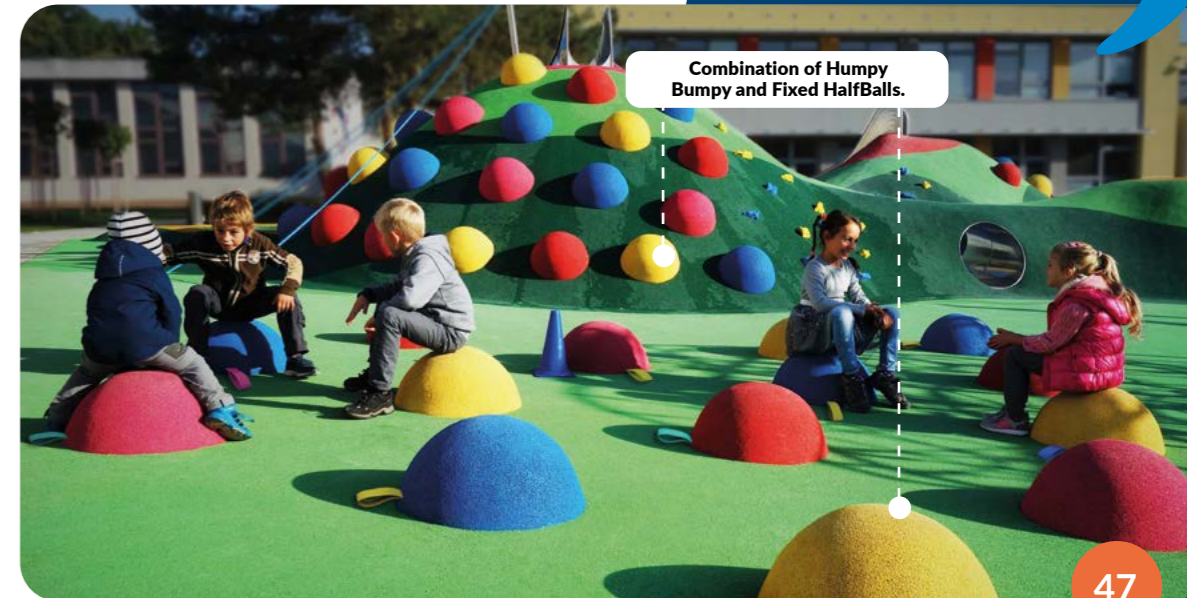

Combination of Humpy Bumpy and Fixed HalfBalls.



MOVE, WHERE YOU WANT

Certified by TUV authorities according to EN 1176-1

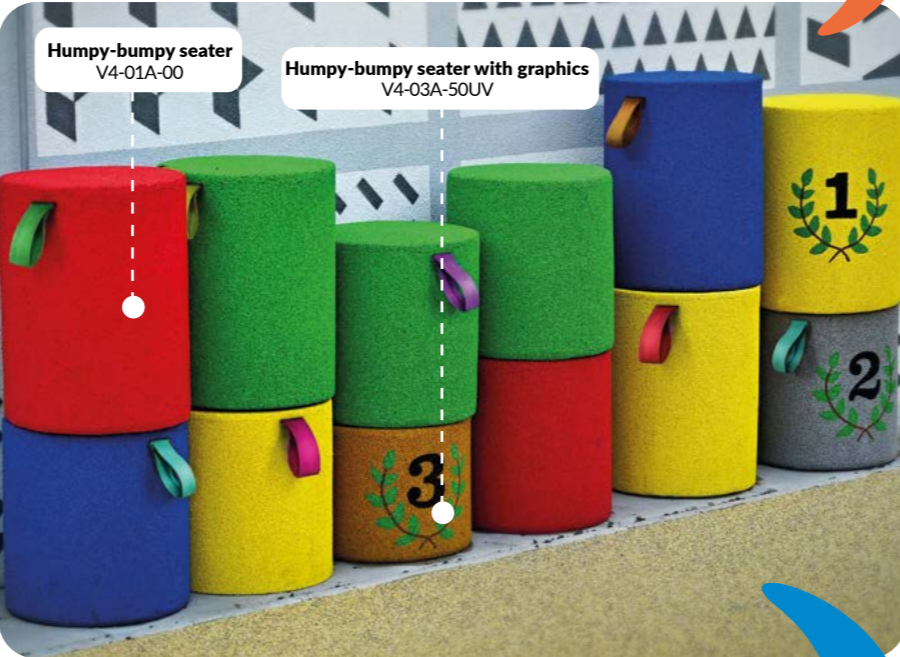

Humpy-bumpy seater
V4-01A-00

Humpy-bumpy seater with graphics
V4-03A-50UV



Humpy-bumpy Turtle
V3-03B-70UV

JUMP



REST

CAN BE USED IN MANY GREAT WAYS

Slide, move, drag, & carry Humpy-Bumpy where you need it.



BALANCE



CARRY

HANDLE WITH STRONG STRAPS



Humpy-bumpy Orange
V3-05A-70UV

Humpy-bumpy LadyBird
V3-02A-70UV

Humpy-bumpy Melon
V3-07A-70UV



Humpy-bumpy seater
V4-01A-50UV

ORIGINAL EQUIPMENT FOR SCHOOLS & KINDERGARTENS
Choose from many designs.

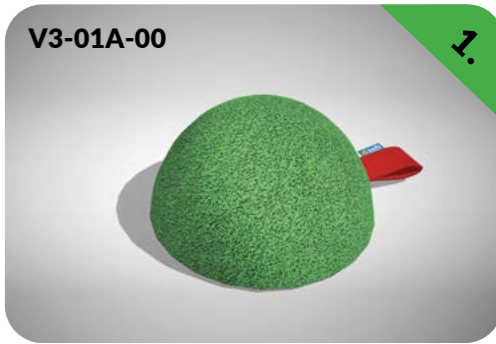

V3-01A-00

HUMPY-BUMPY - SMALL

Diameter: 300 mm, Height: 155 mm
Weight: 9 kg (+/- 1 kg)

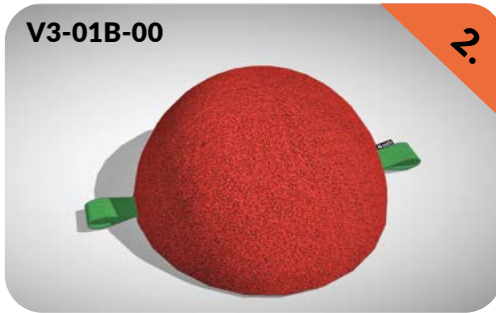

V3-01B-00

HUMPY-BUMPY - BIG

Diameter: 500 mm, Height: 250 mm
Weight: 25 kg (+/- 2 kg)

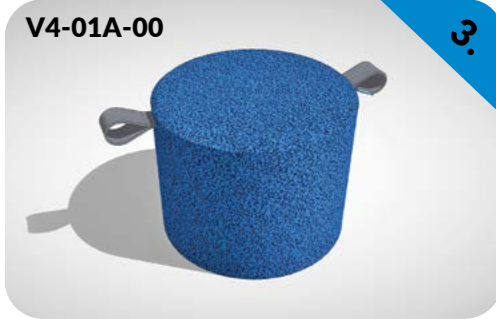

V4-01A-00

HUMPY-BUMPY - SEATER

Diameter: 400 mm, Height: 300 mm
Weight: 25 kg (+/- 2 kg)



CUSTOMIZED WORK

LOGOS & SPECIAL DESIGN

A great way of promoting things. Install logos, messages or a special design directly in the EPDM safety surface.

4soft can make your logo according to details sent by e-mail.

Good promotion of your work or investors, municipalities, sponsors or any other organizations that want to be visible on the playground surface.

ONE SURFACE, MANY USES.



EPDM PANELLING

EPDM PANELLING

CAN BE USED AS:

- decoration of corridors, classrooms and offices;
- an unusual durable bulletin board.

Customizable design and size.



4SOFT *INSPIRATION*

“Help you to create great playgrounds”



GET READY FOR THE SUMMER HEAT!
Pleasant cooling down. :)

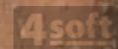

GREAT FUN SAFE

One of the great ways of using wet pour graphics is in areas with mist nozzles, in kindergarten playgrounds, or as refreshing points in public areas etc...



The combination of 3D graphics and splash areas is great in the summer time.

A water nozzle can be put into any 3D shape according to your requirements. Water fountains can be a part of standard playgrounds.



4SOFT SPLASH AREAS

Great in the summer time.

The rest of the year it serves as an attractive and original playground.

You can find out more at:
epdm-graphics.com

WITH
ALL YEAR-ROUND
USE



SET of valve + column
W2-02B



3D Stone (1 pcs)
L1-03A-05

Fish-3
C1-03A-03

3D Octopus
K1-08B-52UV

Splash shower
W2-01B-00

A WATER NOZZLE CAN BE PUT INTO ANY
3D SHAPE ACCORDING TO YOUR REQUIREMENTS

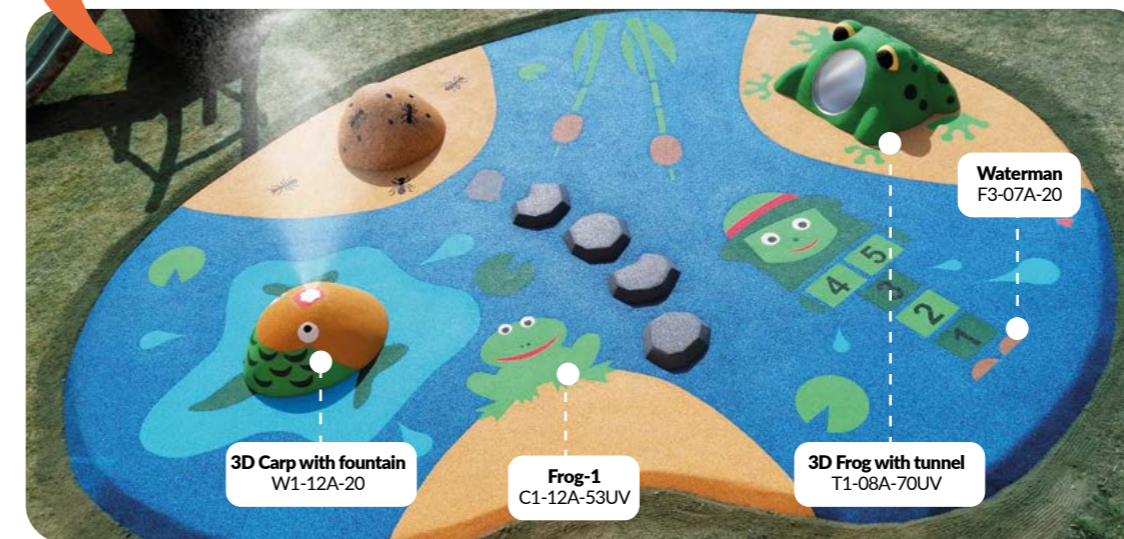

3D Carp with fountain
W1-12A-20

Frog-1
C1-12A-53UV

3D Frog with tunnel
T1-08A-70UV

Waterman
F3-07A-20



3D Whale with fountain
W1-02A-11

Number 8 in circle
A1-03H-56UV

The EPDM surface is water-permeable.
No need for any drainage system.

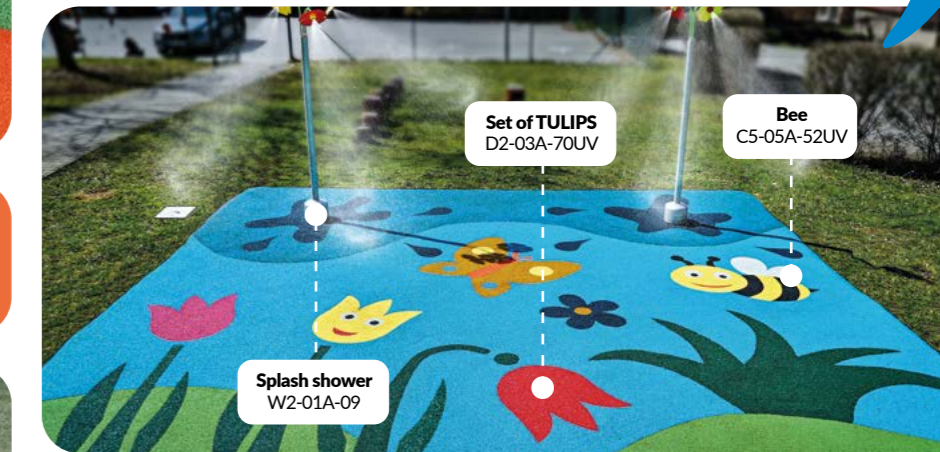

Set of TULIPS
D2-03A-70UV

Bee
C5-05A-52UV

Splash shower
W2-01A-09

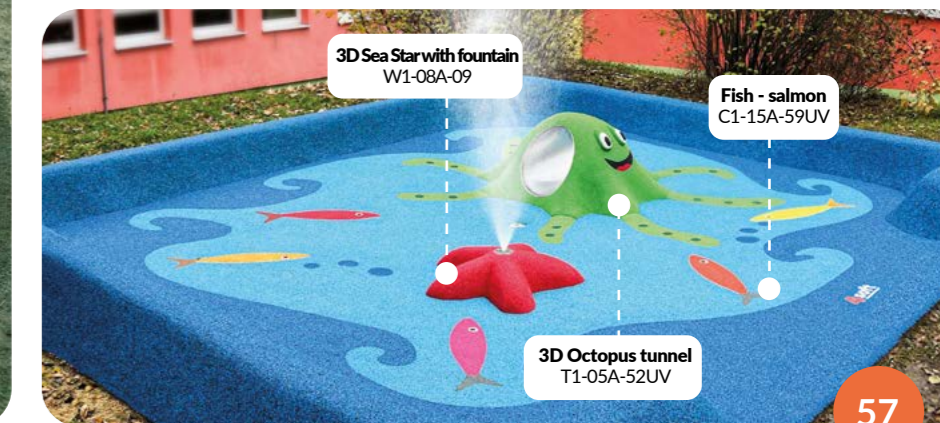

3D Sea Star with fountain
W1-08A-09

Fish - salmon
C1-15A-59UV

3D Octopus tunnel
T1-05A-52UV

SPLASH AREA: 4SOFT INSPIRATION

EXAMPLES AND INSPIRATION

The spray nozzle can be installed into most of our 3D shapes. CHECK OUT www.epdm-graphics.com

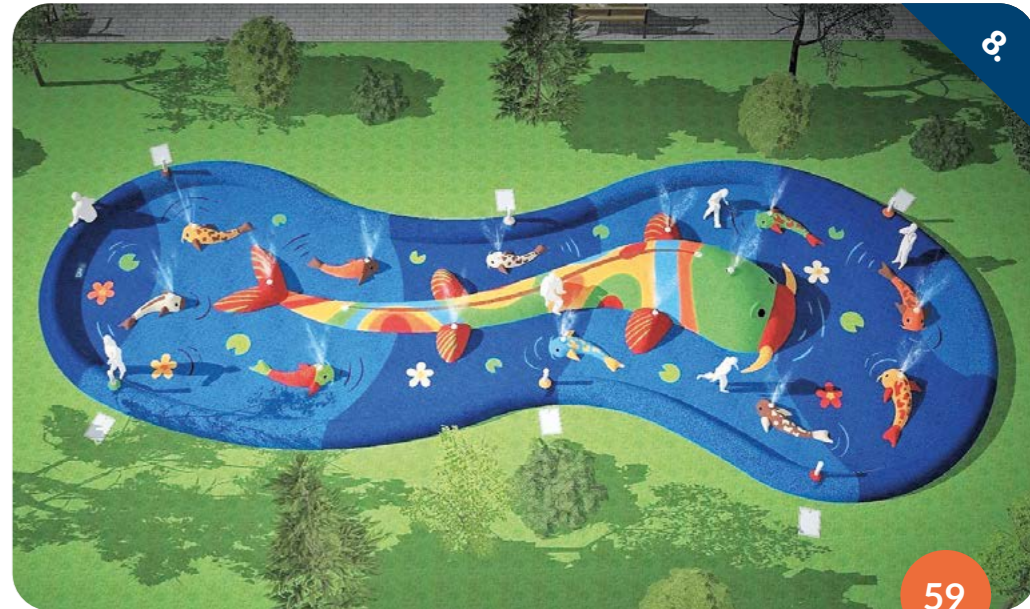

PLAYGROUNDS IN PUBLIC PARKS AND GARDENS

We design exactly according to your requirements and wishes.

Each playground is customized.

Each one is an original.

GREAT
PLAYGROUNDS
TESTED DAILY
BY CHILDREN



Labyrinth
E1-01A-00



3D Hill with fountain
W1-05A-50UV

NICE PLACES NEED
NICE PLAYGROUNDS

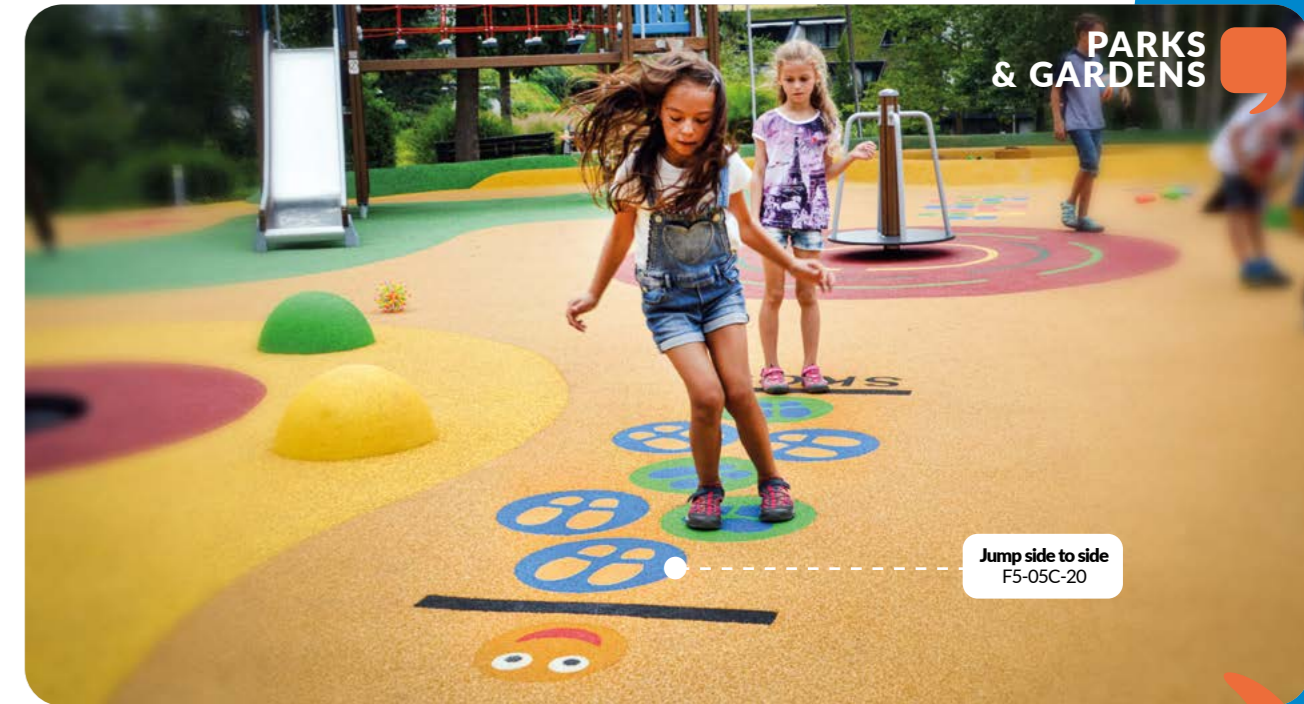

Jump side to side
F5-05C-20

4soft 2D and 3D graphic components multiplying usage of your playground.



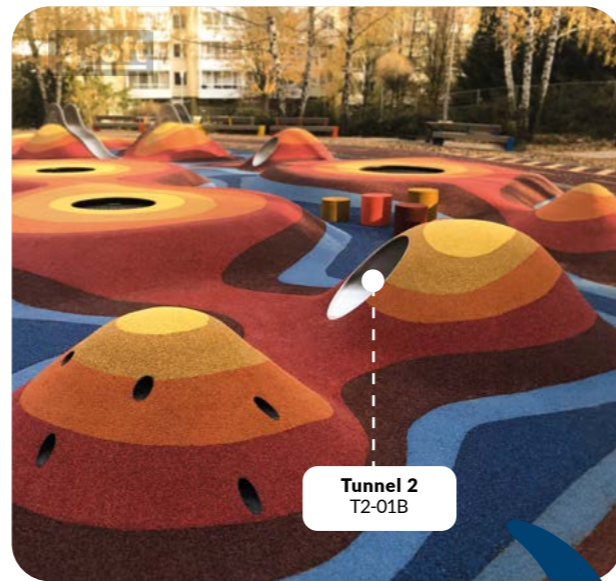
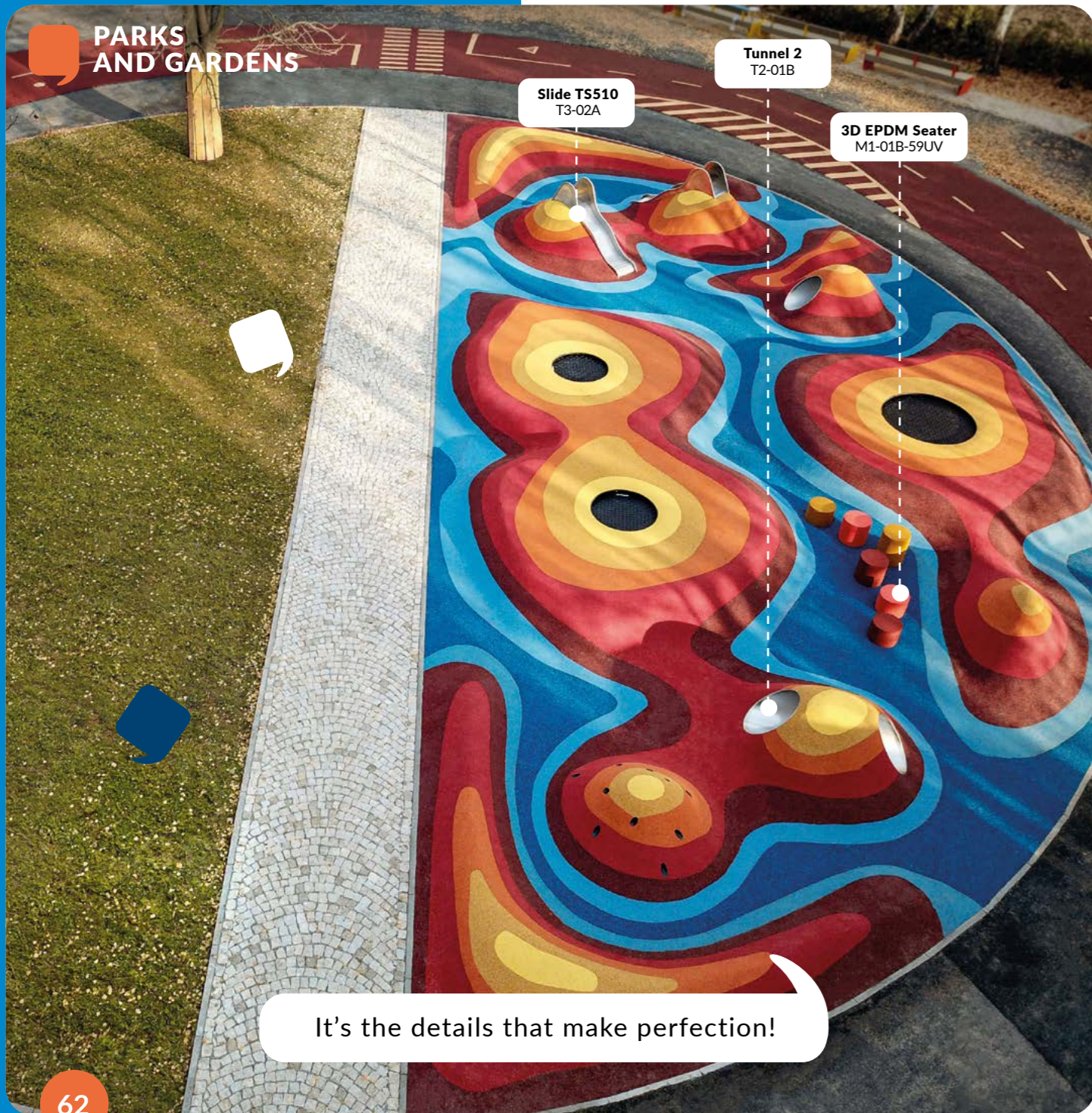

**PUBLIC
PARKS AND
GARDENS**
Quality, tested every day by children.

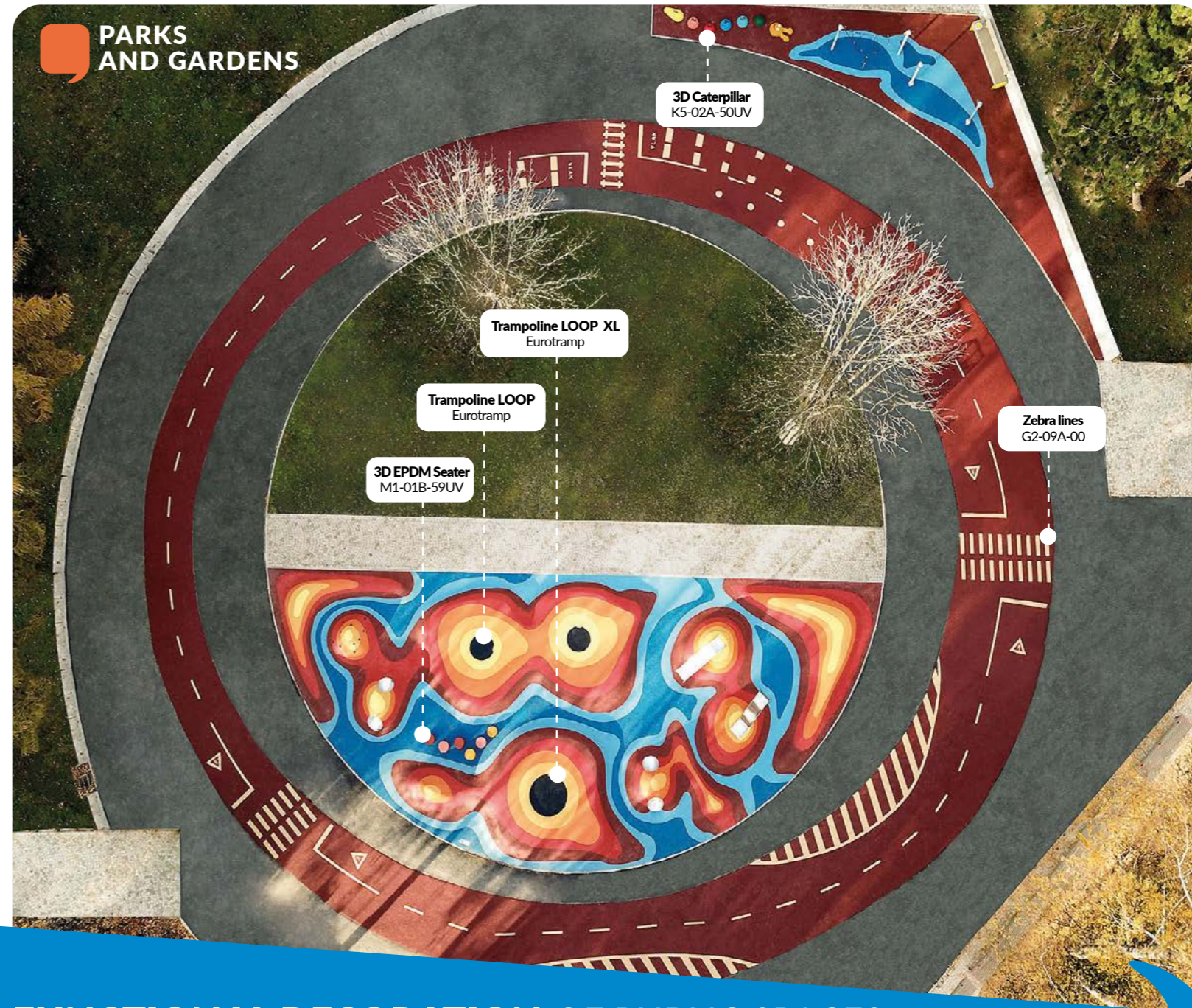

FUNCTIONAL DECORATION OF PUBLIC SPACES

4soft products help develop creativity and fantasy.

**EACH
PLAYGROUND
IS ORIGINAL**

Change boring places into fun and adventurous playgrounds.

We help you to design according to your requirements.

We are not afraid of atypical requirements and ideas. WE LIKE THEM.



Safe playground
without risk of
injury.



We are constantly
working on
Improvements!



A great
playground to
encourages
kids to Play
and Move.



PLAYGROUNDS FOR SCHOOLS & KINDERGARTENS

An exceptional school needs an exceptional play area for its children to have fun during breaks or after school.



RELAX
BY MOVING!

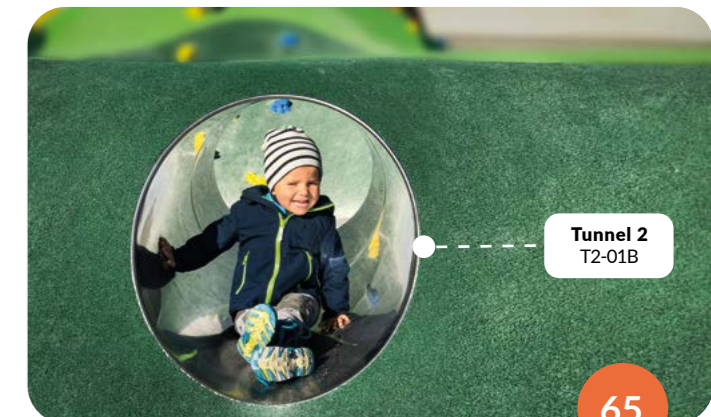

AFTER



PLAYGROUNDS FOR KINDERGARTENS & OTHER PLACES

The unconventional design of the playground means much more fun and usable for children.

Change dull old place into a safe and eye-catching play area.

BEFORE



THERE ARE MANY GREAT WAYS TO USE OUR PRODUCTS



HEAVY-DUTY PLAYGROUNDS

High capacity, durability,
and attractiveness.



Trampoline LOOP
Eurotramp

Residential areas, shopping malls, city parks and places with high through traffic.

STYLISH MODERN PLAYGROUNDS INCLUDE NOT ONLY CLASSIC PLAY ELEMENTS



Tunnel 3
T2-01C

3D EPDM Seater
M1-01C-01

Do
playgrounds
entice
children to
move
naturally?



We offer many
small but useful
products to make
play areas more
entertaining.

**ORIGINAL
3D PLAYGROUND**
The advantage of working
with EPDM surfaces is the
ability to of shape it into big
hills and waves.
You can create unconventional
and catchy play elements.



3D EPDM Seater
M1-01C-01

4soft can produce atypical hemispheres in individual designs and diameters up to 2.5m and weight about 200Kg. Good on roofs, for example.



PLAYGROUNDS SHOPPING MALLS

Exceptionally durable and safe surfaces with high aesthetic and play value.



For greater stability we use metal anchor for some 3D components.

UNUSUAL 3D PLAYGROUND
Create fully functional playgrounds composed of these 3D 4soft products.

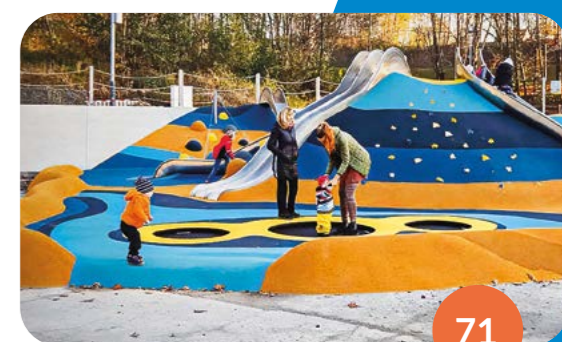

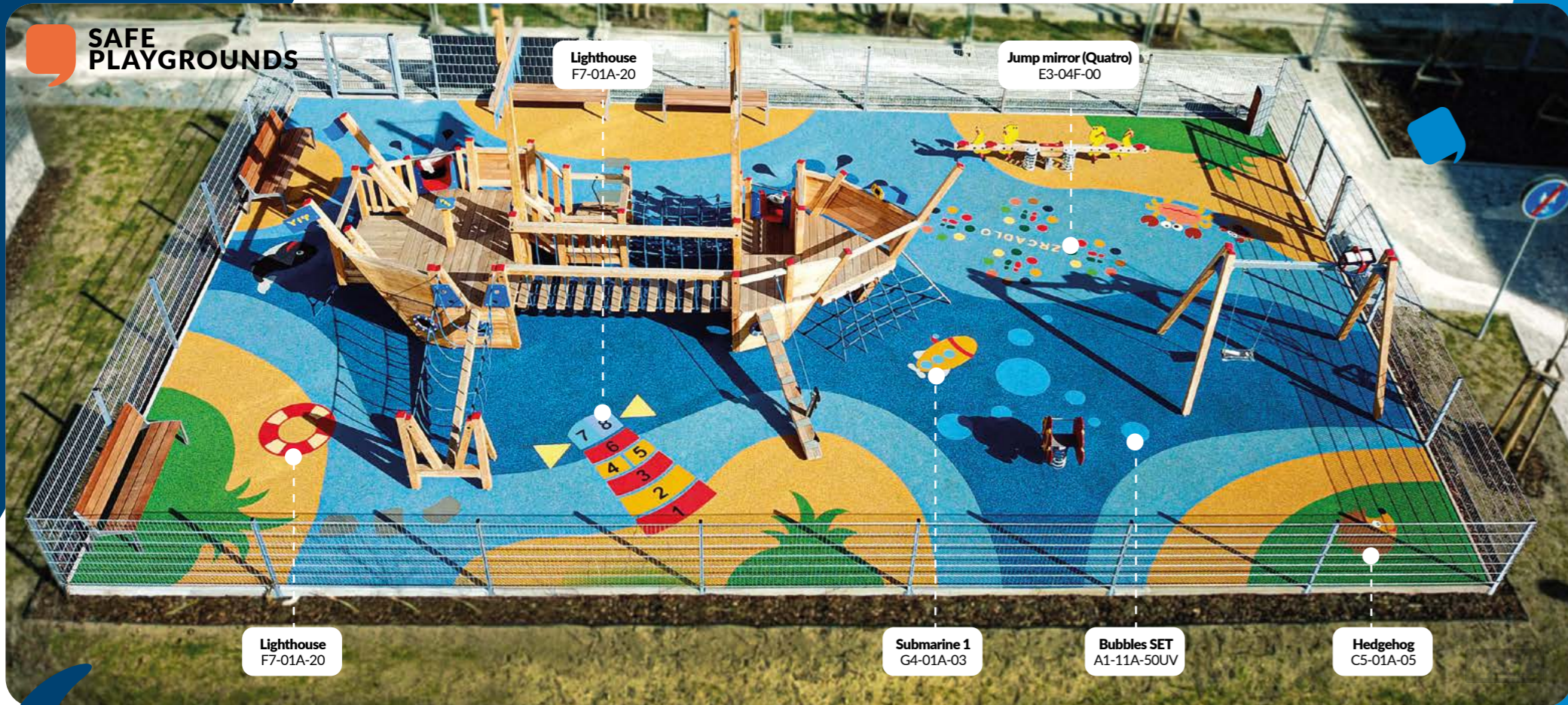

SAFE PLAYGROUNDS

HOUSING ESTATES

A safe year-round playground without fear of children getting dirty or injured.

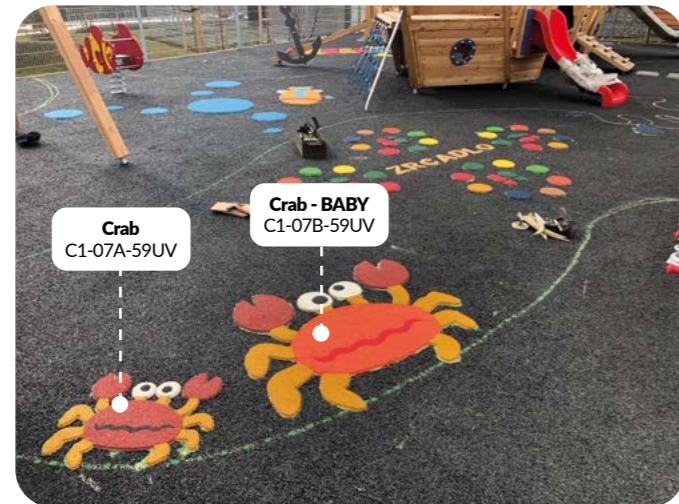

SAFE PLAYGROUNDS

MULTIPLY THE POTENTIAL & ATTRACTIVENESS OF THE SPACE

Same place, same play equipment but different impression.



4SOFT GRAPHICS

The most effective way of creating an interesting EPDM surface.

PLAYGROUNDS: 4SOFT INSPIRATION

EXAMPLES AND INSPIRATION

We create graphic designs exactly according to your requirements and possibilities. We help you Fast and Free of charge.

EXAMPLES AND INSPIRATION



MULTI-PURPOSE PLAYGROUNDS

A smart and economical solution for use of space in kindergartens and primary schools.

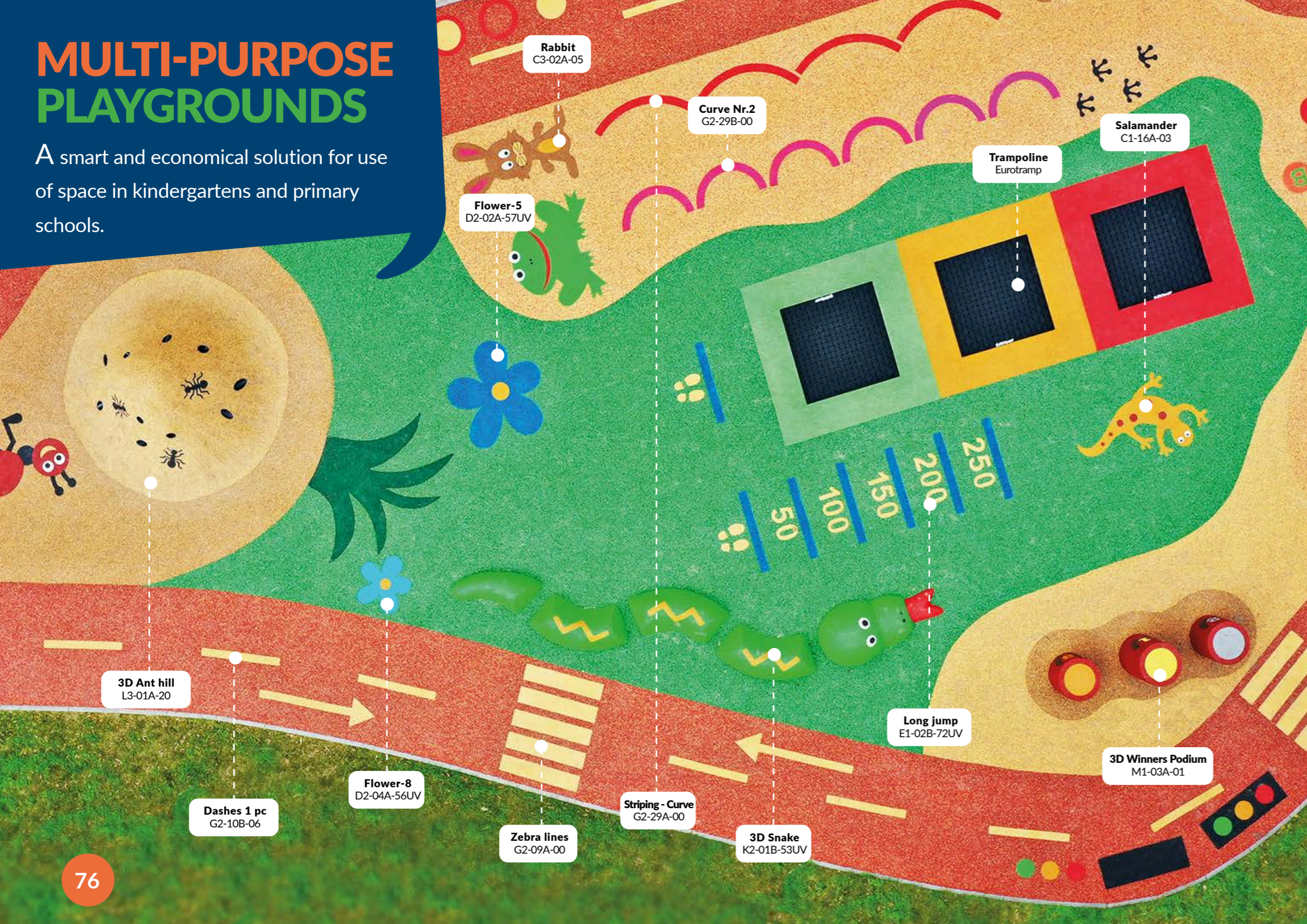

Places for learning, sports, relaxation and entertainment.



Small sports grounds for ball games.



Small traffic parks for ride-on toys.



Our graphics department is constantly working to come up with new 2D and 3D fun themes that will multiply the play potential and attractiveness of your playground.



FUN & SPORT



LEARN & RELAX



MULTI-PURPOSE AREAS

Playgrounds with sports, competition and educational themes.



Areas for drawing pictures in chalk. EPDM graphic components help to encourage children's creativity.





Ludo BIG
E3-01A-00

Caterpillar Small
F6-01A-03

Long jump
E1-02B-72UV

3D Ant hill
L3-01A-20

Set of letters A-Z in circle
A1-06A-70UV

Clock
E2-01A-03

Striping - street line "L"
G2-22A-02

Hopscotch Small-girl 1
F1-04A-00

Jump mirror - Animals
E3-04A-00

TRAFFIC EPDM PLAYGROUNDS

With our graphics, it is easy to make traffic playgrounds for small kids.

Children will learn the basics of traffic education - getting over the road safely at a pedestrian crossing and recognizing the colours of traffic lights.

Playgrounds like this increase the quality of time spent outdoors.

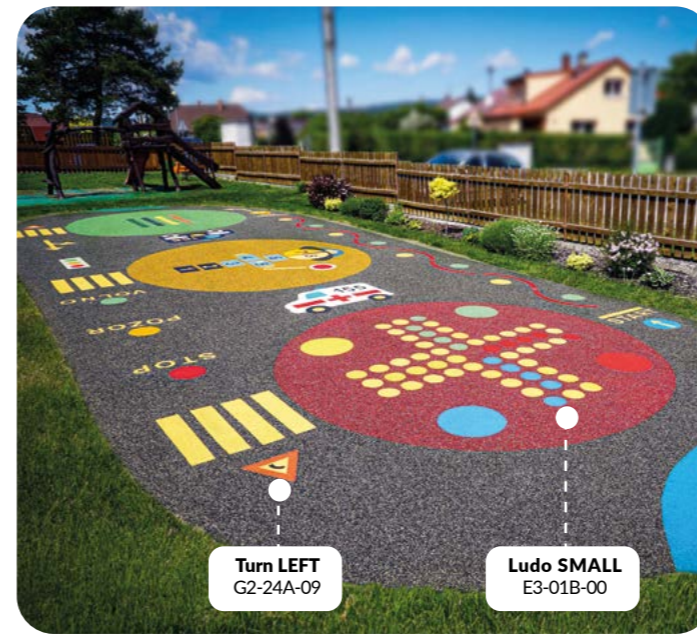

Turn LEFT
G2-24A-09

Ludo SMALL
E3-01B-00

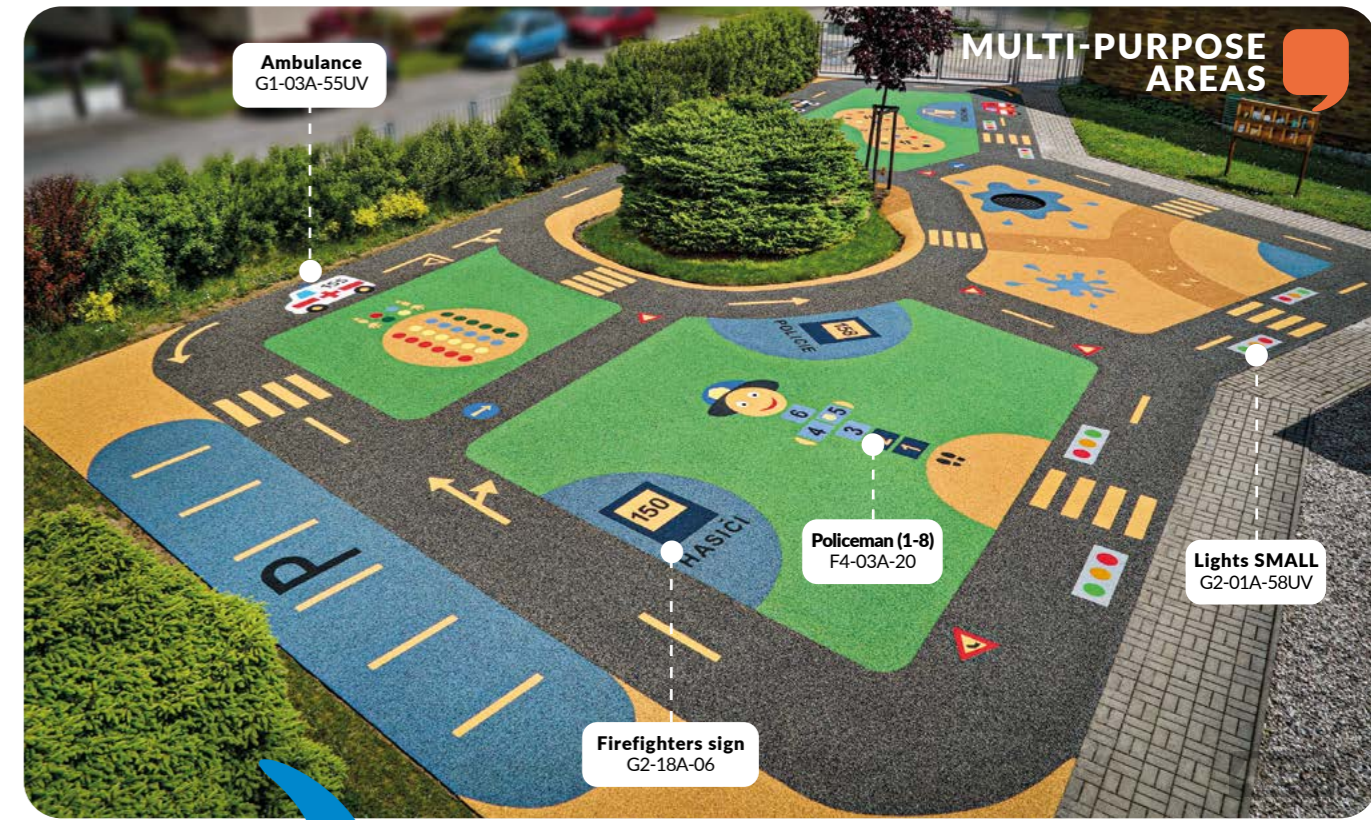

Ambulance
G1-03A-55UV

Policeman (1-8)
F4-03A-20

Lights SMALL
G2-01A-58UV

Firefighters sign
G2-18A-06

Ideal for riding on kids scooters bicycles & toy trucks.



THREE, TWO, ONE, GO!!!

Racing on tracks with different kinds of fun and challenging 2D and 3D graphic components.



FOR KINDERGARTENS PLAYGROUNDS

With one investment we create a area that can also serve as:

- a small sports field for ball games;
- an outdoor classroom with educational graphic elements;
- a place for outdoor theatre performances;
- a small traffic playground for scooters and bicycles;
- an adventure playground;
- a water splash playground great on hot days.



ONE AREA MANY OPTIONS FOR USE

There are many ways to use our products.

We would like to suggest some smart solutions for your playgrounds.



A place for learning, sports and entertainment with 4soft products.

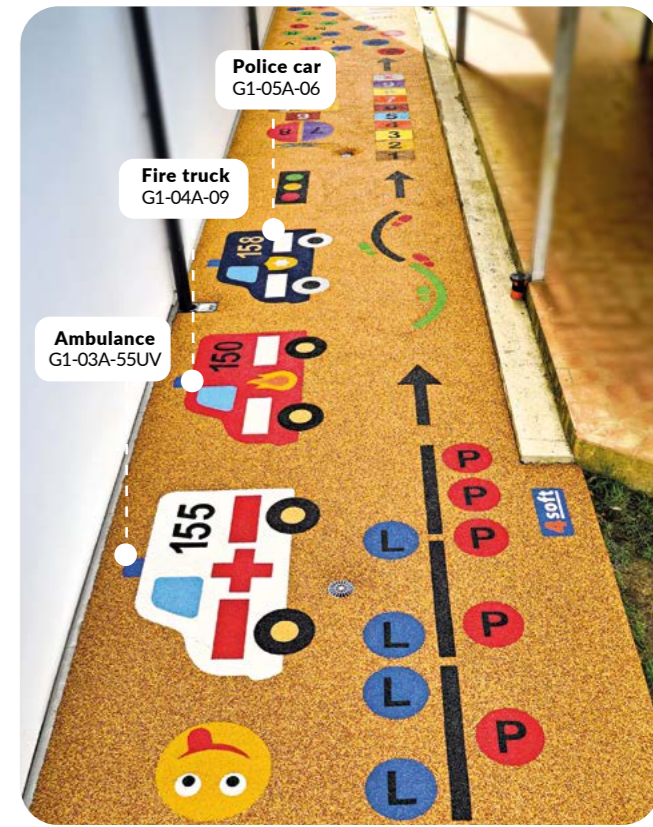

REST AREAS & MEETING PLACES

EPDM surfaces from 4soft graphics are really suitable for places where the emphasis is on safe movement, maximum durability and at the same time a great look.

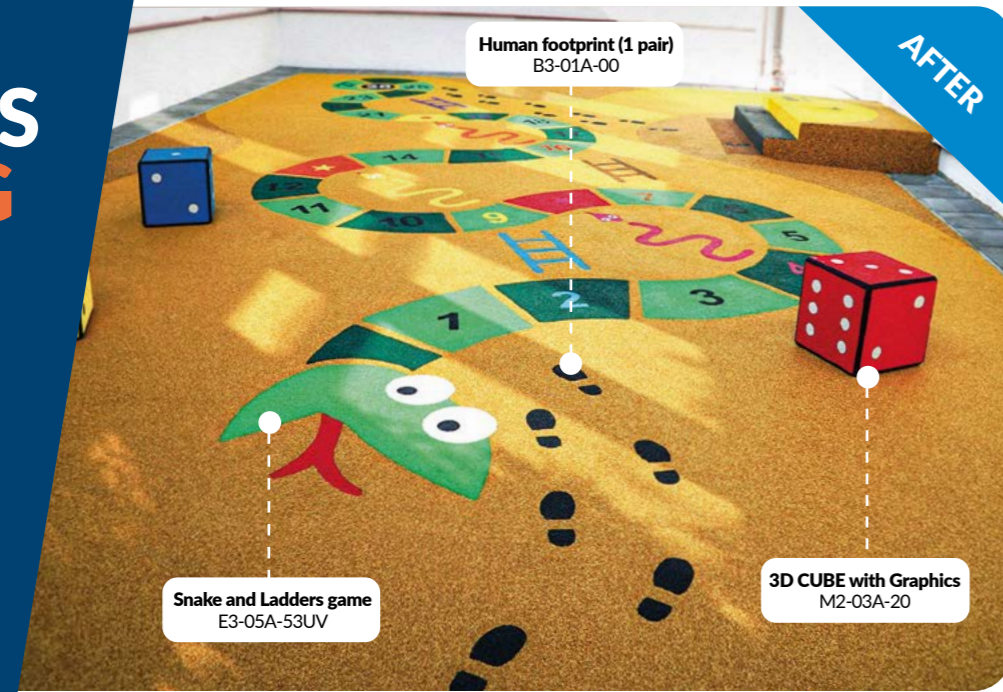

Unused area of a school courtyard transformed into a recreation and play area.



Smart and simple solution for public spaces with 3D seaters.



SPORT, PLAY AND FUN IN ONE PLACE!



MULTI-PURPOSE AREAS FOR GAMES & SPORT

Use 4soft sports and jumping graphics to create a place not only for ball-game activities.



Use existing asphalt and concrete areas.

This solution saves money you can then use a more pleasant surface.



MULTI-PURPOSE AREAS: 4SOFT INSPIRATION

EXAMPLES AND INSPIRATION

There are plenty of ways to use a playground, it just depends on your imagination and needs. We help you to create an original playground area exactly according to your ideas.

EXAMPLES AND INSPIRATION



SCHOOL SPORTSGROUNDS

Thanks to the prefabricated 4softgraphics, sports grounds can have a wide range of options for various movement games and sports.

FOCUSED
ON DIFFERENT AGE
GROUPS OF STUDENTS



Bench PLAY DIRECT
V1-01A-50UV

Attractive for all generation.



By using smartly combined amusing graphic components and sports lines, it is possible to create a single area that meets the demands for classic sports as well as children's games.

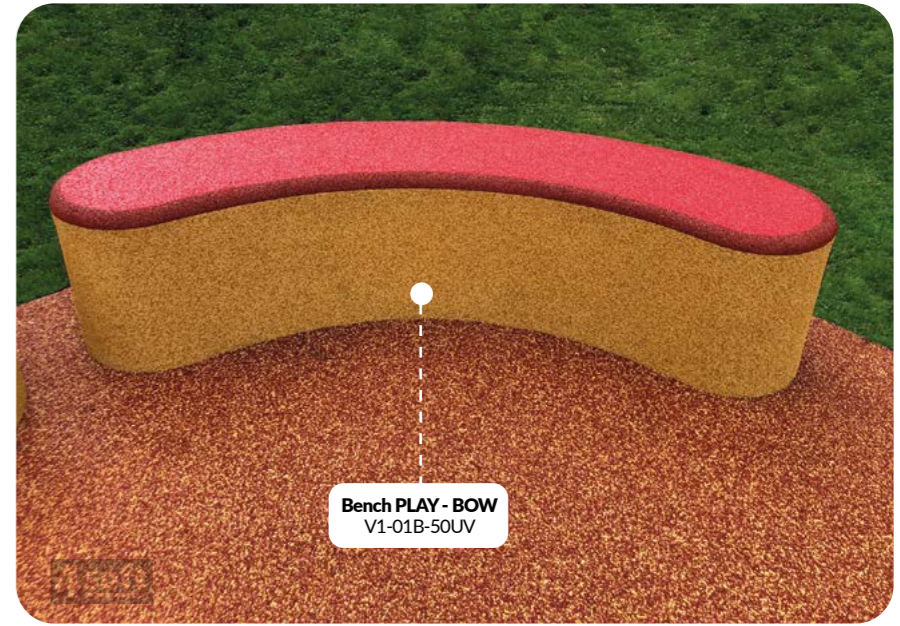

Bench PLAY - BOW
V1-01B-50UV



3D CUBE - COLOURS
M2-01B-50UV

SMALL COMPACT SPORTS GROUND

A budget-friendly and efficient solution for small schools, day care centres or smaller communities.



Long jump (0-300)
E1-02B-71UV

Do more sport activities in one place. Play soccer, volleyball or basketball, then play hopscotch, hit the target or do workout exercises!



Target - big
E1-05A-20

ORIGINAL DESIGN AND EQUIPMENT

Special goal, seating for spectators, entertaining and competition graphics. Make the maximum from small space!

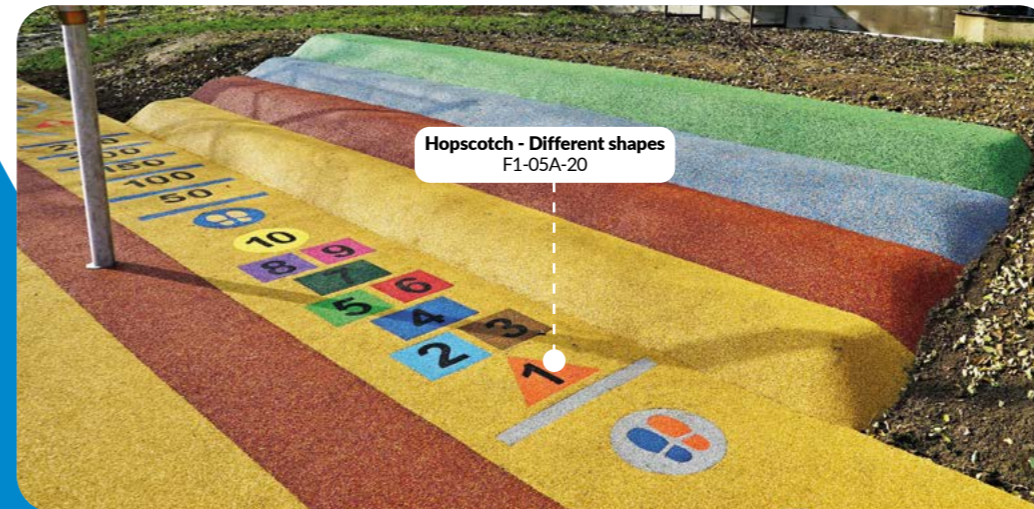

Hopscotch - Different shapes
F1-05A-20



4soft
basketball goal



Long jump (0-300)
E1-02B-72UV

MULTI-FUNCTIONAL SPORTS GROUND

We focus on all athletes. Each one can find his or her right activity.
Sport, play entertainment.

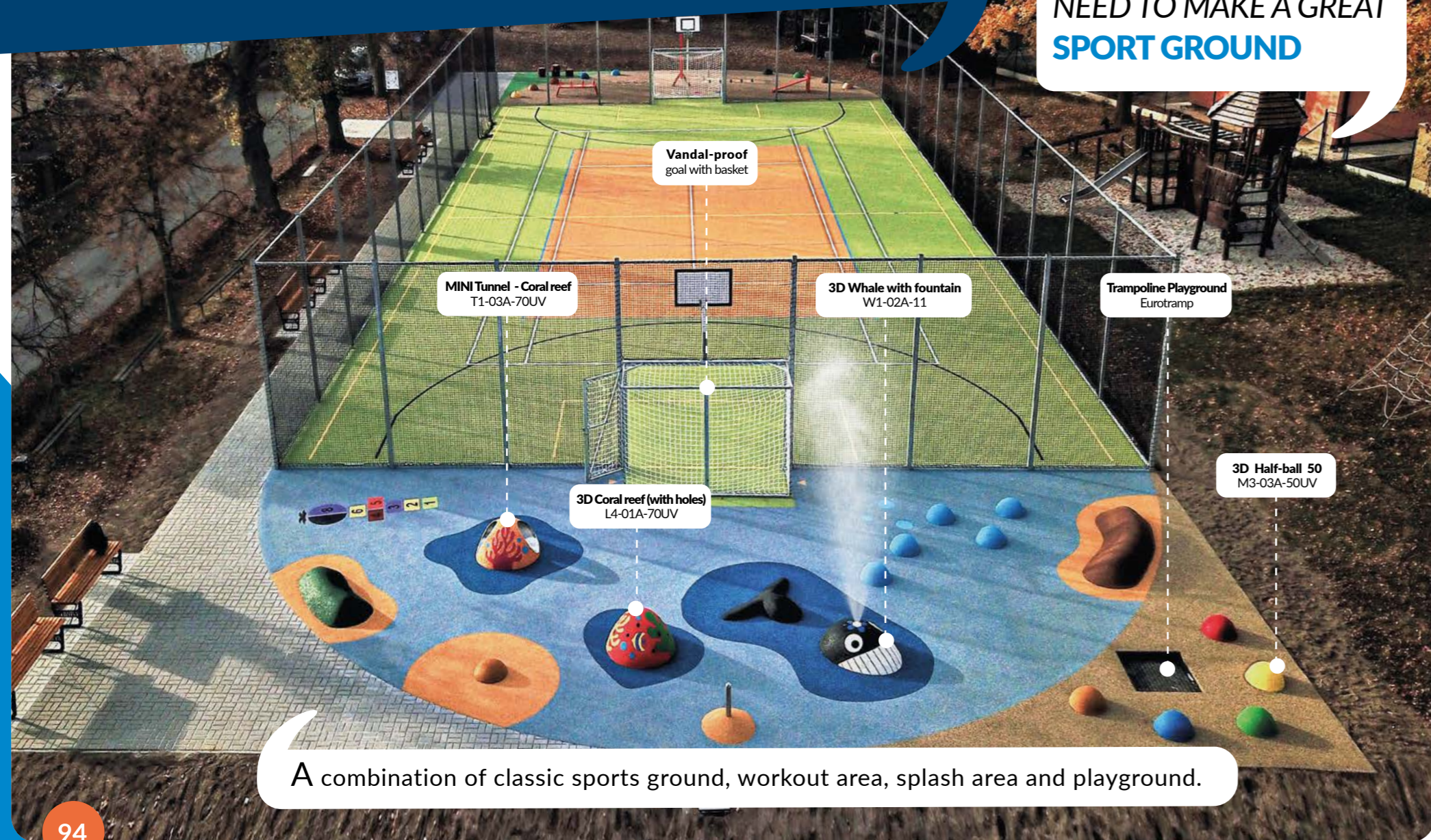

4SOFT - ALL YOU NEED TO MAKE A GREAT SPORT GROUND

A combination of classic sports ground, workout area, splash area and playground.



Attractive for kids of all ages.



Make the sports grounds truly multi-purpose.



Ideal for outdoor gym classes.



Use the sports & jumping graphics.

GET KIDS TO MOVE!

We design sports facilities with an emphasis on natural interest in being active.



DURABLE AND SAFE
No cracking inside the graphic components.
Stable and durable joints.

EFFICIENT AND ECONOMICAL

Combination of sports area and playground.

With one effective investment you get a truly a multi-functional sports area for young and old alike.



4SOFT SPORS GROUNDS: 4SOFT INSPIRATION

EXAMPLES & INSPIRATION



We offer effective and smart solution for many clients. CHECK OUT www.epdm-graphics.com

EXAMPLES & INSPIRATION



SUPER GRAPHICS AROUND TRAMPOLINES

Great fun play equipment for all ages.

To Increase entertainment value use 2D and 3D graphic components.

We use Eurotramp trampolines.



Space rocket
F2-03A-20

Trampoline Playground
Eurotramp

Astronaut
F2-02C-59UV

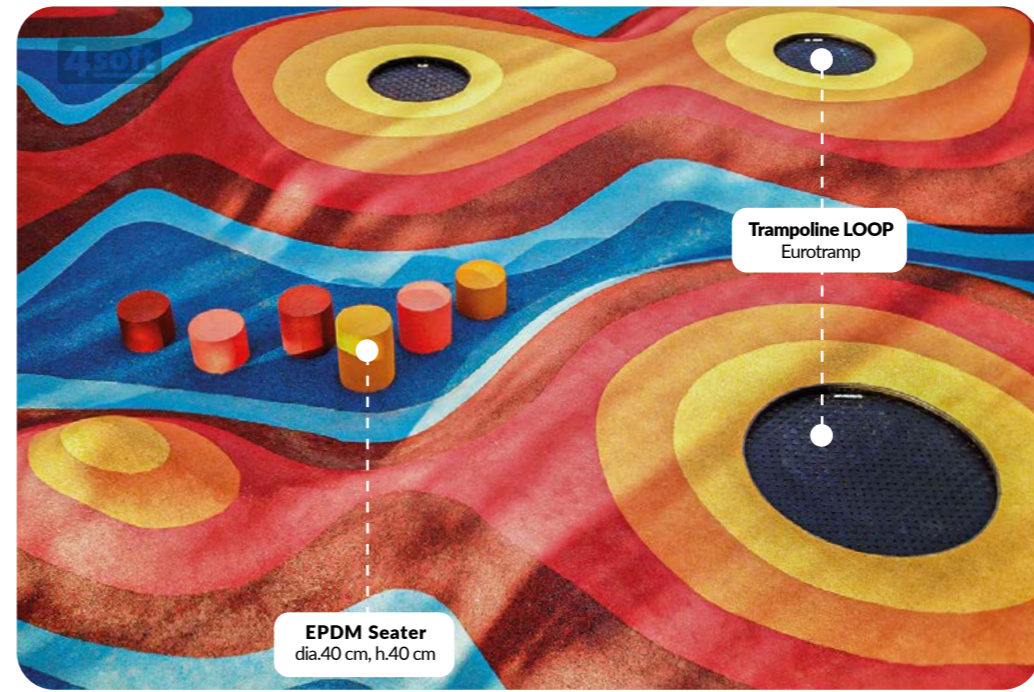

Trampoline LOOP
Eurotramp

EPDM Seater
dia.40 cm, h.40 cm

MORE 3D COMPONENTS - MORE FUN



3D Hemisphere 50
M3-03A-50UV

Letters, numbers, footprints and other pictures in EPDM surface gives jumping a goal.



Letters A- Z
I2-02A-00



Four-leaf clover 1-4
B1-02A-07

Bird - footprint
B1-02A-07

Bird - footprint
B1-02A-07

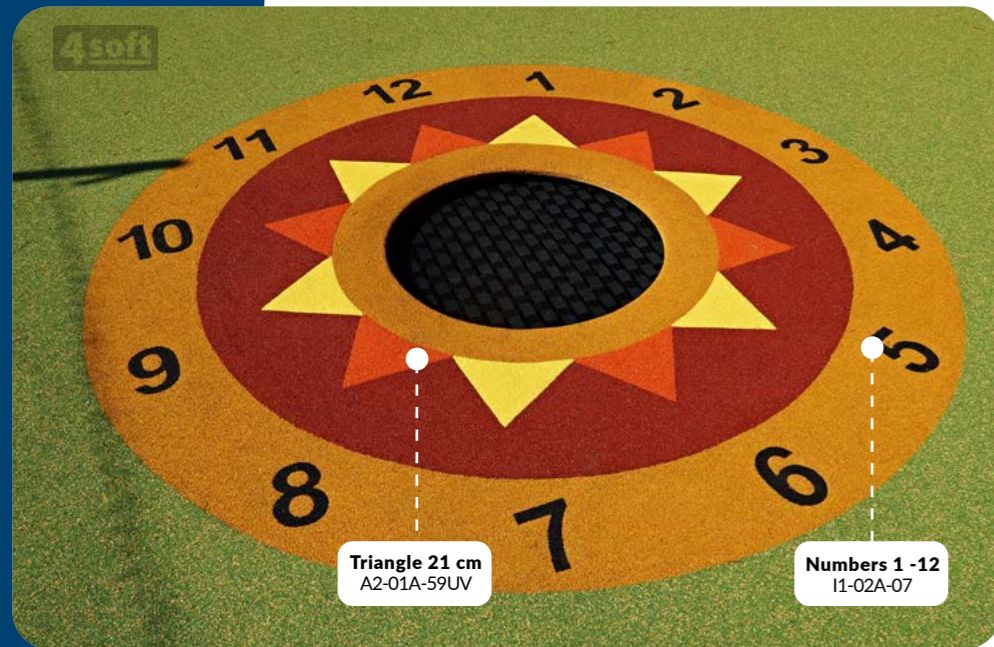

Super combination with hills, slides and tunnels.

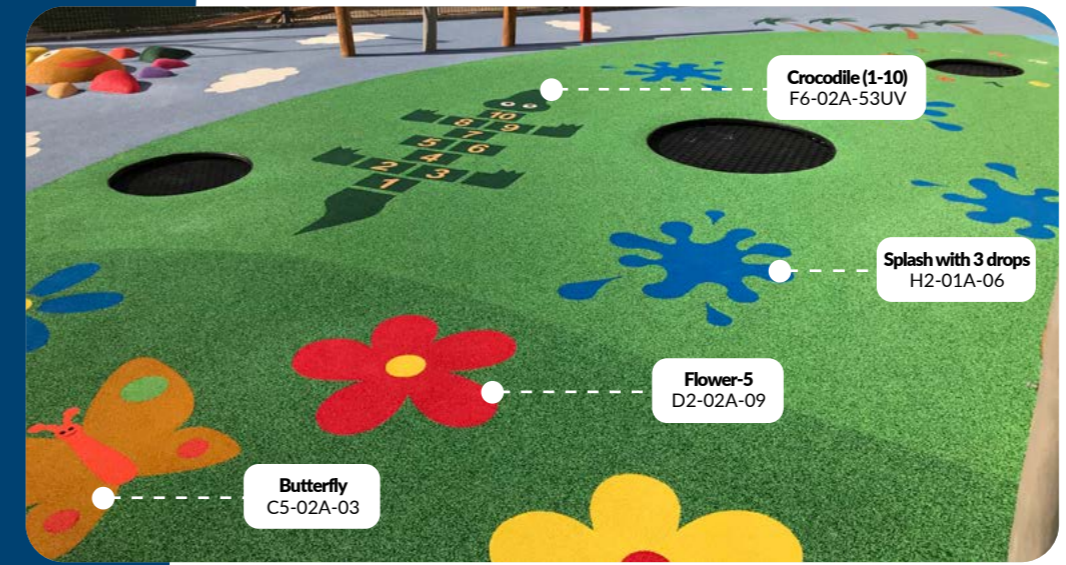
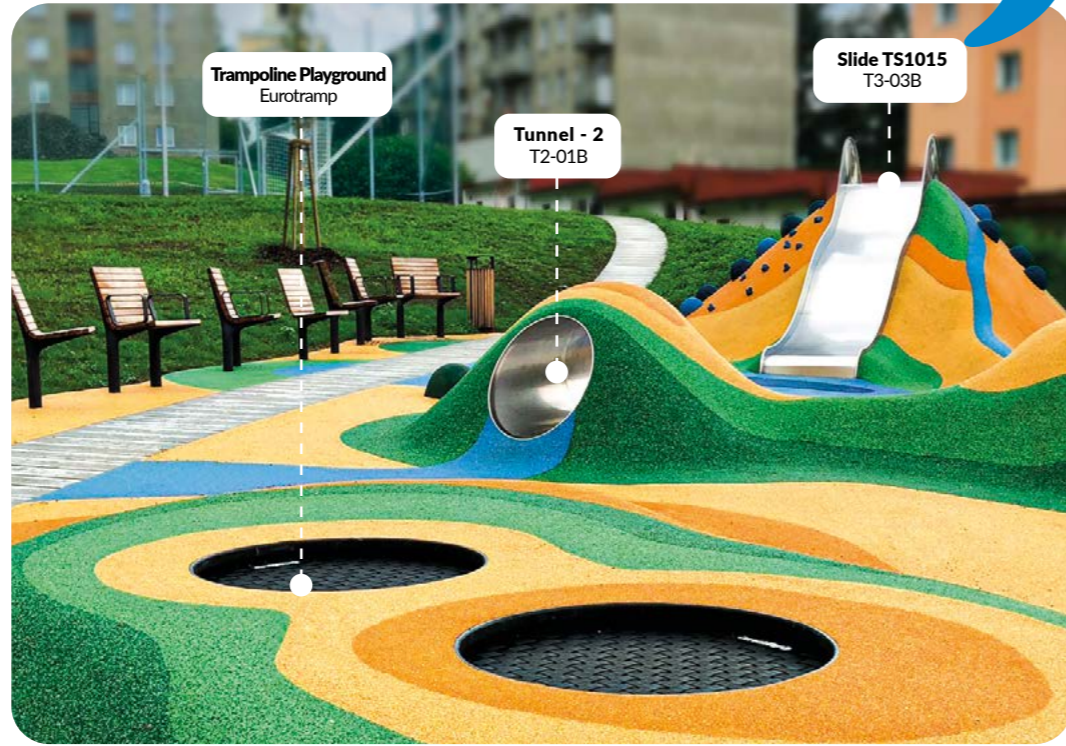

TRAMPOLINE PLAYGROUNDS

Pictures and 3D elements add interactivity...

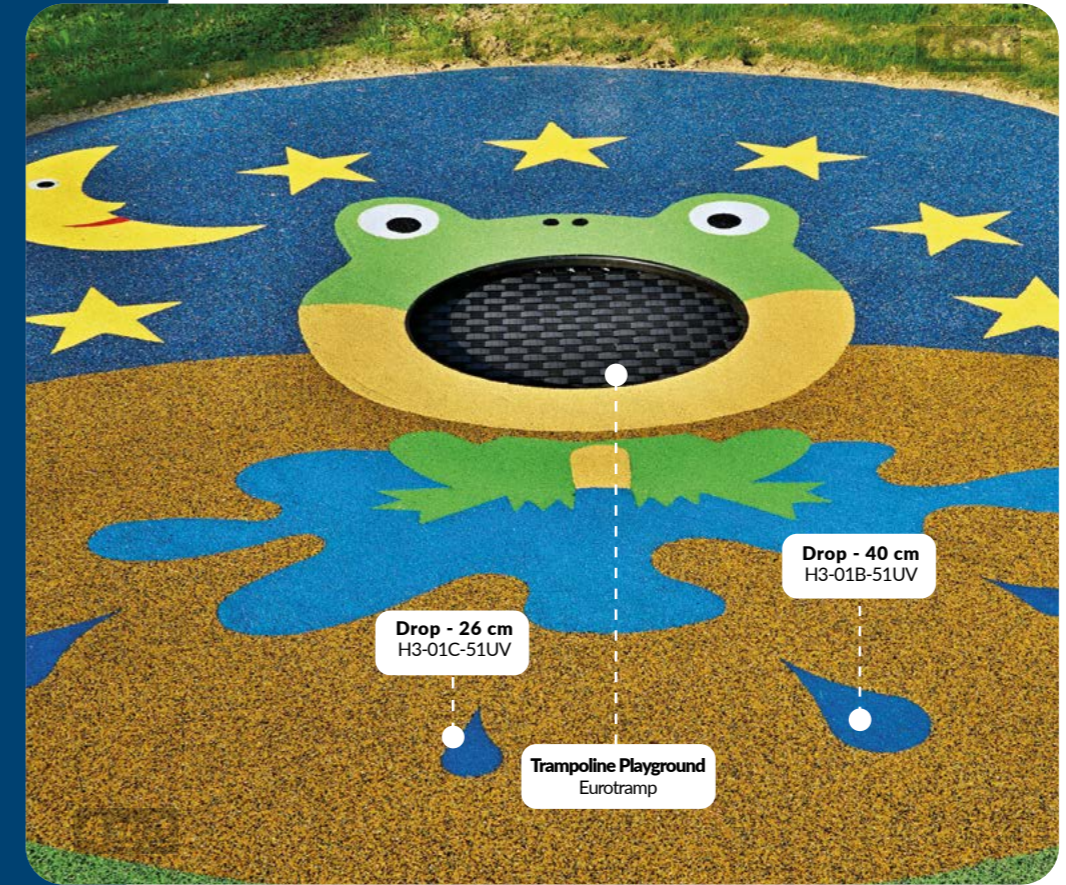

TRAMPOLINE PLAYGROUND: INSPIRATION

These playgrounds encourage children to move and have fun.

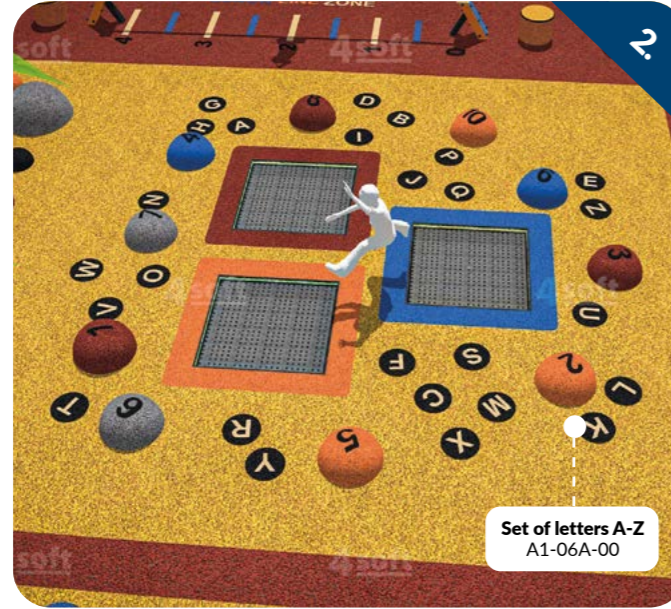

EXAMPLES
& INSPIRATION

TRAMPOLINE
PLAYGROUNDS

TRAMPOLINES WITH 4SOFT GRAPHICS

Safe heavy-duty
equipment for outdoor and
indoor use.



Excellently compatible
with 4soft EPDM
graphic components.





Fire hose nozzle
G3-02A-58UV

4soft hopscotches, geometric shapes, traffic signs, logos etc. Make the children happy.



Hydrant
G3-03A-09

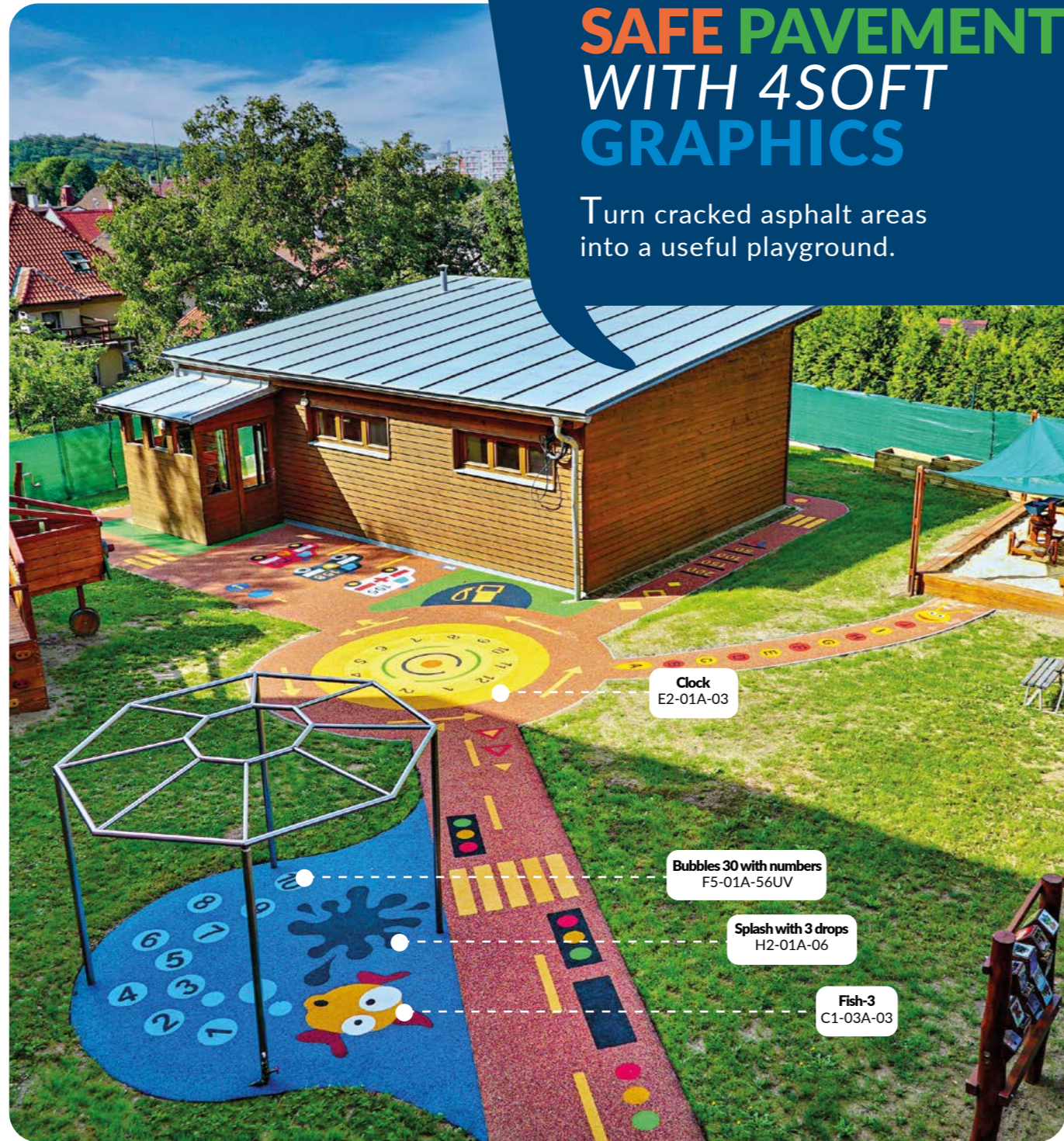

SAFE PAVEMENT WITH 4SOFT GRAPHICS

Turn cracked asphalt areas into a useful playground.

Clock
E2-01A-03

Bubbles 30 with numbers
F5-01A-56UV

Splash with 3 drops
H2-01A-06

Fish-3
C1-03A-03



Jump leaves with numbers
F5-03A-00

Lights SMALL - black
G2-01A-07

CHOOSE THE RIGHT GRAPHIC COMPONENTS & GLUE THEM



Fireman 3
F4-01C-20

Give an old garden path a new and interactive life!

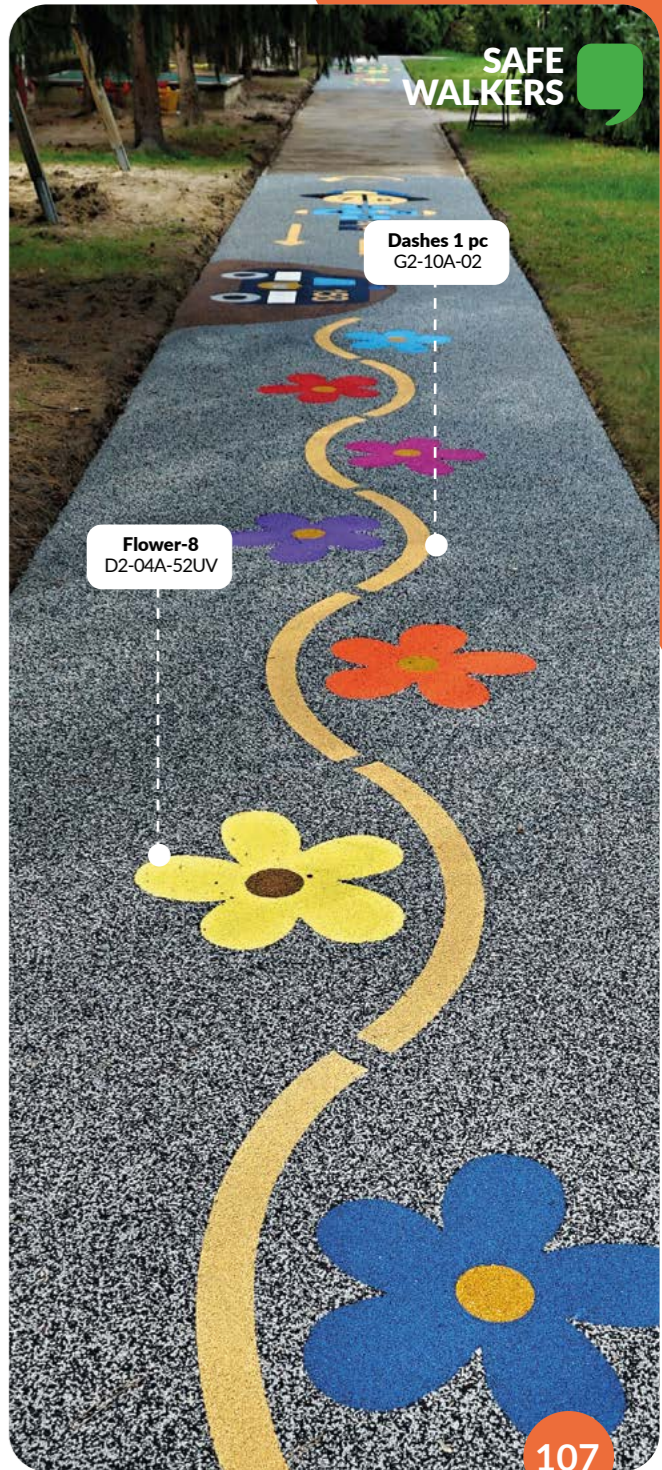

Dashes 1 pc
G2-10A-02

Flower-8
D2-04A-52UV

SAFE WALKERS



Even terraces can become a play area!



SAFETY TERRACES

EPDM terraces with 4soft graphics.

These places are usually forgotten when creating wet pour surfaces even though there is often an almost ready sub-base for direct installation.



A PLACE FOR LEARNING, SPORTS AND ENTERTAINMENT

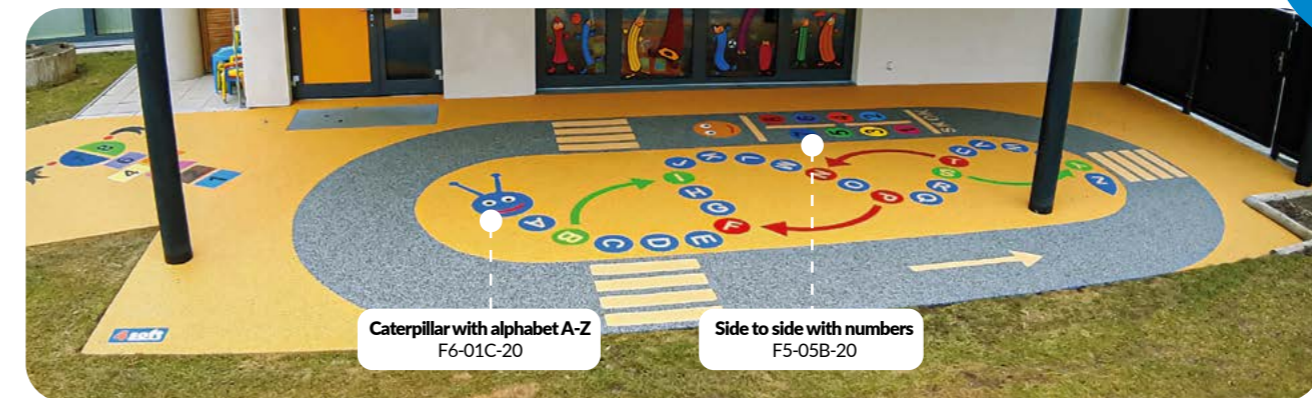

FAST, EASY, EFFECTIVE
PERFECT SOLUTION



SAFE WORKOUT AREAS

With EPDM graphics combination with EPDM pictures and symbols creates a spectacular type of sports field.

Can be use for small sportsmen or big ones.

**ALL-YEAR
EXERCISE ON A SAFE
EPDM SURFACE
WITH 4SOFT GRAPHICS!**

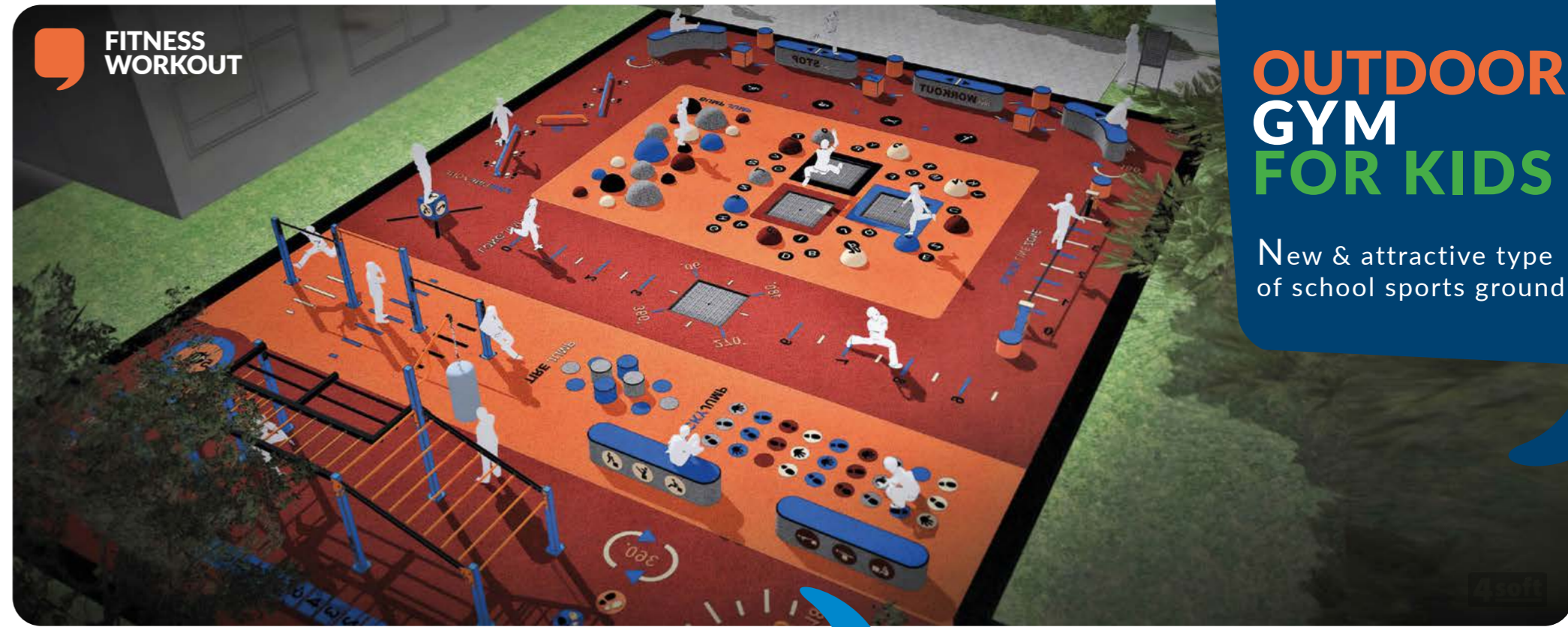

OUTDOOR GYM FOR KIDS

New & attractive type of school sports ground



A space that motivates children to participate in movement games.

A great area for active breaks or leisure activities after school.





PITS MADE FROM EPDM
Shading is a welcome addition not only to our 3D sandboxes.

3D Ant hill
L3-01A-20

A more usable, fun and safe sandpit.



4soft

Tunnel 3
T2-01C

3D EPDM Seater
M1-01C-01

Triangle with graphics
A2-04Z-50UV

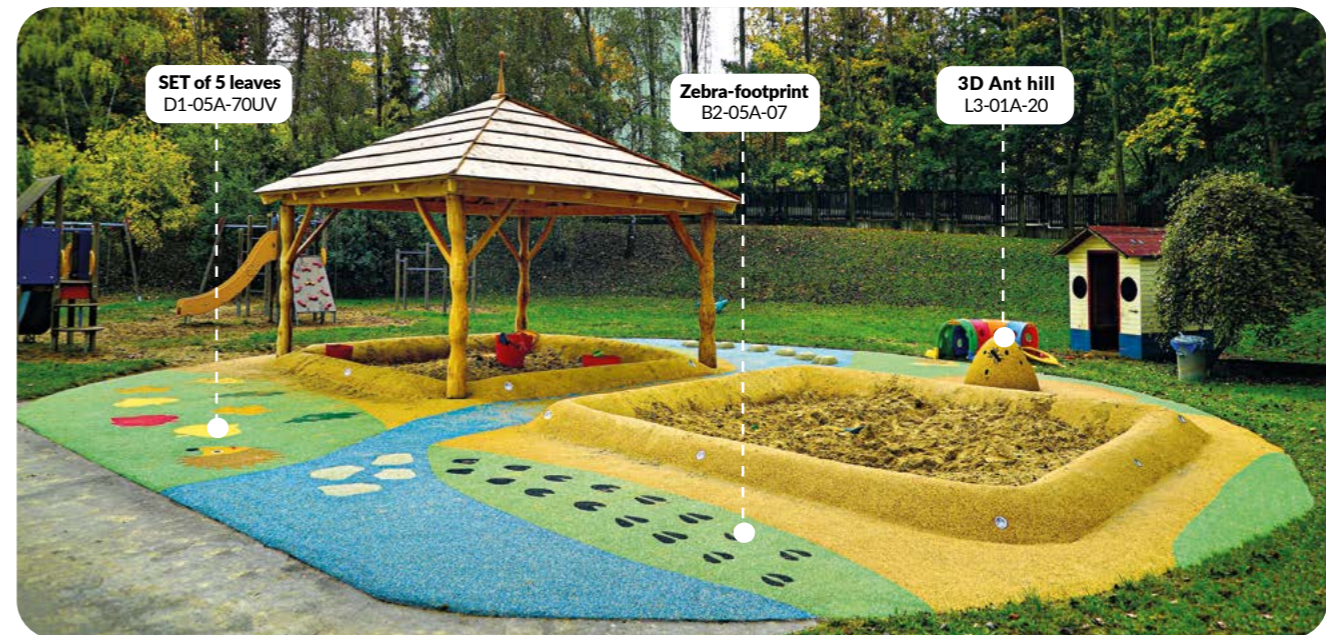

SET of 5 leaves
D1-05A-70UV

Zebra-footprint
B2-05A-07

3D Ant hill
L3-01A-20

3D SANDBOX COMBINATIONS ARTIFICIAL & NATURAL SURFACE

Sandpit perimeter in the form of a soft mound becomes an attractive yet safe balancing track for running along.

At the same time it is a perfect perfect place for children to sit.

The inside of the sandpit is ideal for installing other play elements such as tunnels, slides, balancing elements, ball tracks, etc.



EPDM Seater
dia.40 cm, h.40 cm



4soft

3D SANDBOX: 4SOFT INSPIRATION



With our graphics, we turn ordinary surfaces into interesting places full of activities.



Way direction sign
G2-21A-57UV

Zebra lines - one
G2-09A-02

The 3D Seater can be good for playing with sand, sitting on or jumping over.



3D Turtle with tunnel
T1-07A-05



Jump mirror
E3-04C-00

MINI Tunnel
stainless steel

Small-boy
F1-03A-00





3D Ant hill
L3-01A-20

LIST OF 2D/3D GRAPHICS

“Creativity has no limits”

4SOFT GRAPHICS

Before we start offering a particular graphic to others, we test its effect, function and its potential. We develop a graphics portfolio based on our own experience.



2D BASIC SHAPES



- A1-01A-00 Circle Ø18 cm
- A1-01C-00 Circle Ø30 cm
- A1-01D-00 Circle Ø40 cm
- A1-01E-00 Circle Ø50 cm
- A1-01F-00 Circle Ø60 cm
- A1-01G-00 Circle Ø65 cm
- A1-01H-00 Circle Ø70 cm
- A1-01I-00 Circle Ø80 cm
- A1-01J-00 Circle Ø100 cm
- A1-01K-00 Circle 120 cm



- A1-13Z-00 Circle Ø30 with graphics
- A1-14Z-00 Circle Ø40 with graphics
- A1-17Z-00 Circle Ø50 with graphics
- A1-16Z-00 Circle Ø60 with graphics
- A1-20Z-00 Circle Ø70 with graphics
- A1-19Z-00 Circle Ø80 with graphics
- A1-21Z-00 Circle Ø100 with graphics
- A1-18Z-00 Circle Ø120 with graphics



- A3-01A-00 Square 19 cm
- A3-01B-00 Square 30 cm
- A3-01C-00 Square 35 cm
- A3-01D-00 Square 40 cm
- A3-01E-00 Square 50 cm
- A3-01F-00 Square 60 cm
- A3-01G-00 Square 70 cm
- A3-01H-00 Square 100 cm



- A2-01A-00 Triangle 21 cm
- A2-01B-00 Triangle 40 cm
- A2-01C-00 Triangle 50 cm
- A2-01D-00 Triangle 70 cm
- A2-01E-00 Triangle 100 cm



- A2-04Z-00 Triangle 40 cm with graphics
- A2-02Z-00 Triangle 50 cm with graphics
- A2-03Z-00 Triangle 100 cm with graphics

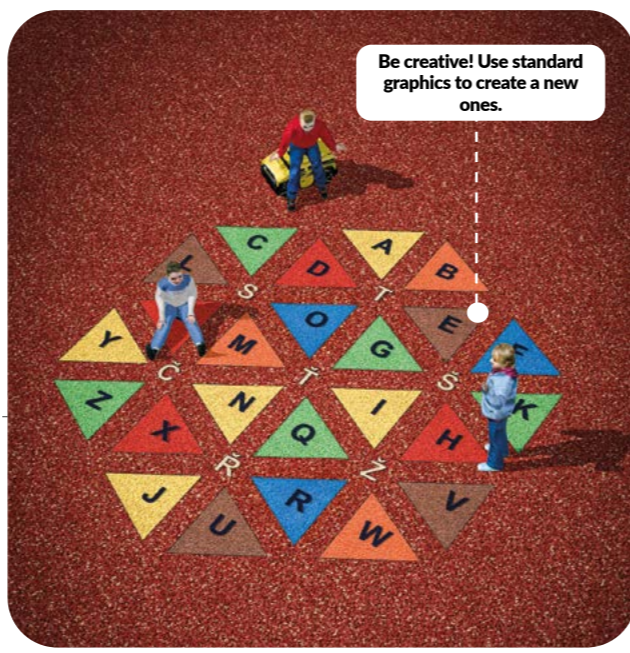
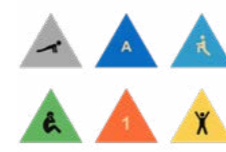

- A4-01A-00 Rect. 20 x 15 cm
- A4-01B-00 Rect. 40 x 28 cm
- A4-01C-00 Rect. 50 x 25 cm
- A4-01D-00 Rect. 63 x 30 cm
- A4-01G-00 Rect. 100 x 50 cm
- A4-01H-00 Rect. 100 x 75 cm
- A4-01E-00 Rect. 85 x 30 cm
- A4-01F-00 Rect. 90 x 70 cm



- A4-03Z-00 Rect. 50x25 cm with graphics
- A4-02Z-00 Rect. 40x28 cm with graphics



- Bubbles set SMALL (6pcs) A1-11B-50UV
- Bubbles set BIG (6pcs) A1-11A-00



- A5-01A-00 Star 17cm
- A5-01B-00 Star 50cm
- A5-01C-00 Star 100cm

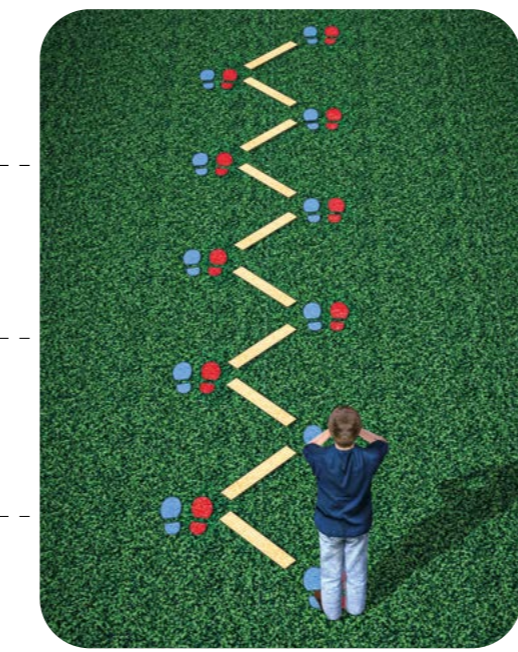

2D FOOTPRINTS



- Human foot-print (1 pair) 28 x 10 cm B3-01A-00



- Hippo - foot-print (1 pc) 19 x 25 cm B2-01A-59UV



- Lion - foot-print (1 pc) 19 x 20 cm B2-02A-02



- Elephant - foot-print (1 pc) 30 x 30 cm B2-03A-03



- Camel footprint 22 x 20 cm B2-03A-03



- Zebra - foot-print (1 pc) 24 x 20 cm B2-05A-00



- Giraffe - foot-print (1 pc) 22 x 20 cm B2-06A-07



- Gorilla - foot-prints (1 pair) 34 x 44 cm B2-08A-07



- Salamander - foot-print (1 pair) 17 x 23 cm B1-01A-07



- Turtle - foot-prints (1 pair) 20 x 17 cm B2-07A-05



- Bird - foot-print (1 pc) 17 x 13 cm B1-02A-07



- Sheep foot-print (1 pc) 23 x 9 cm B4-01A-07



- Giraffe - foot-print (1 pc) 22 x 20 cm B2-06A-07



- Frog - foot-print (1 pc) 24 x 18 cm B1-03A-53UV



Rabbit - foot-print (1 pair)
17 x 30 cm
B1-04A-07



Human hand print (1 pair)
20 x 22 cm
B3-02A-02



Dolphin-1
C1-08A-61UV



Head of crocodile
85x67 cm
C1-09A-04



Sea horse
105x60 cm
C1-10A-03



Fish-5
80x75 cm
C1-11A-54UV
Fish-5 BABY
50x50 cm
C1-11B-59UV



Sea star
100 x 95 cm
C1-02A-09



Frog-1
110x95 cm
C1-12A-53UV



Frog - Cussed prince
110x95 cm
C1-12B-53UV



Octopus 2D - standard colours
135x110 cm
C1-13A-00

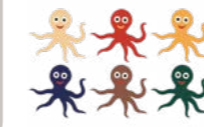

Ant Small - 2
28x25 cm
C2-01B-07



Ant
110x100 cm
C2-01C-01



Bat
100x50 cm
C2-02A-07



Squirrel
120x85 cm
C2-03A-59UV



Fish-4
110x75 cm
C1-04A-59UV



Fish-4 Cussed princess
105x75 cm
C1-04B-03



Turtle-1
110x100 cm
C1-06A-05

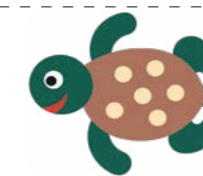

Crab
115x100 cm
C1-07A-59UV
Crab - BABY
50x50 cm
C1-07B-59UV

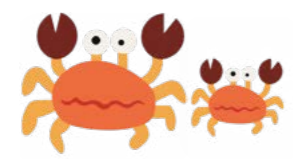

Turtle-2
115x130 cm
C1-06B-04

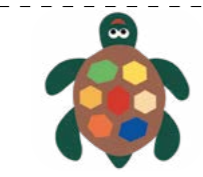

Penguin
90 x 90 cm
C1-01A-07



PRODUCTS COMBINATION!

There are many ways to use our products. We would like to suggest some smart solutions for your playgrounds.



Octopus 2D
135x110 cm
C1-13A-52UV



Fish-6
120x86 cm
C1-14A-52UV



Fish - salmon
100x26 cm
C1-15A-03



Salamander
115x80 cm
C1-16A-03



Ant Small - 1
33x20 cm
C2-01A-07

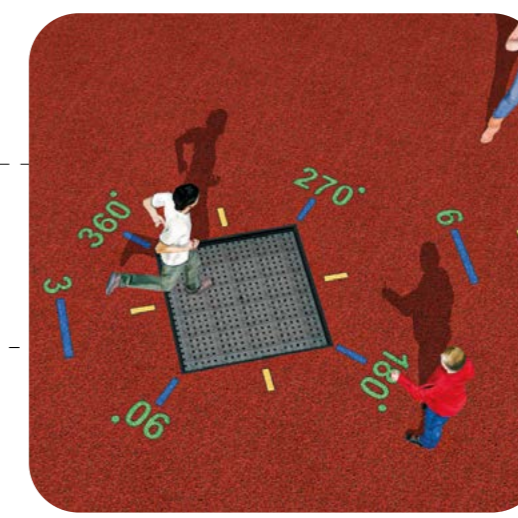

Duck
100x100 cm
C3-01A-52UV



Butterfly
95x100 cm
C5-02A-03



Kitty
90x90 cm
C3-03A-20



Rabbit
110x75 cm
C3-02A-05



Hedgehog
100x85 cm
C5-01A-05

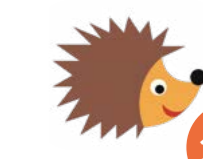

Fish-3
115x100 cm
C1-07A-59UV
Fish-3 BABY
50x50 cm
C1-07B-59UV

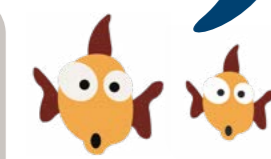

Whale
125x75 cm
C1-05A-11



Dog
130x100 cm
C3-04A-20



Buterfly - BIG
270x240 cm
C5-02B-03



Bee
110x85 cm
C5-05A-52UV



Head of caterpillar
95x52 cm
C5-06A-03



Fox
C2-04A-59UV



Owl
90 x 90 cm
C2-05A-05



Earthworm
90x55 cm
C5-08A-12



Snail
105x102 cm
C5-04A-02
Snail - BABY
40x38 cm
C5-04B-02



Ladybird - 2D
115x120 cm
C5-03A-01



Dino-1
110x72 cm
C4-01A-53UV



Parrot
110x65 cm
C4-04A-20



Lion
125x100 cm
C4-02A-03



Elephant
100x95 cm
C4-03A- 65UV



Snake-2 (set of 11 pcs)
520 cm
C4-05A-53UV



Snake - Head
110x90 cm
C4-05B-53UV



Giraffe - male
C4-06A-52UV
Giraffe - female
C4-06B-52UV
Giraffe - BABY
C4-06C-52UV



Giraffe - BABY
80x45 cm
C4-06D-52UV



For more inspiration CHECK OUT
www.epdm-graphics.com



Mouse
90x85 cm
C5-07A-65UV



2D NATURE

Maple leaf
65x70 cm
D1-01A-03



Leaf Linden
70x90 cm
D1-02A-53UV

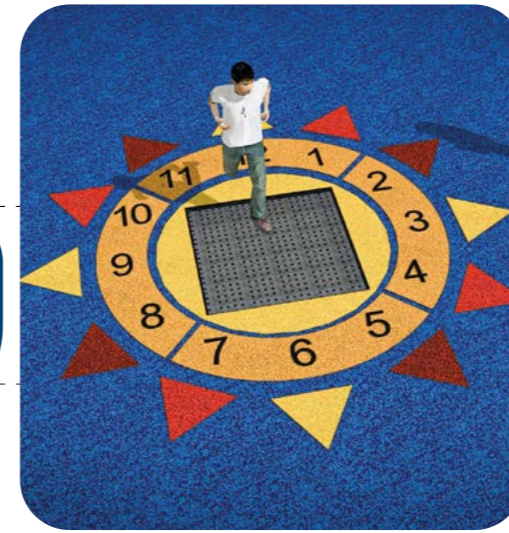

Leaf Oak
45x95 cm
D1-03A-04



Four-leaf clover
65x70 cm
D1-04A-04
Four-leaf clover with numbers
100x100 cm
D1-04B-53UV



Leaf Chestnut
80x70 cm
D1-08A-05



SET of 5 leaves
D1-05A-70UV



Leaf Beech
65x100 cm
D1-06A-01



Palm tree - right
120x80 cm
D1-07A-04
Palm tree - left
120x80 cm
D1-07B-04



Water-lily with graphics
50 cm
D1-09Z-50UV



Water-lily
30 cm
D1-09A-53UV
Water-lily
70 cm
D1-09C-04

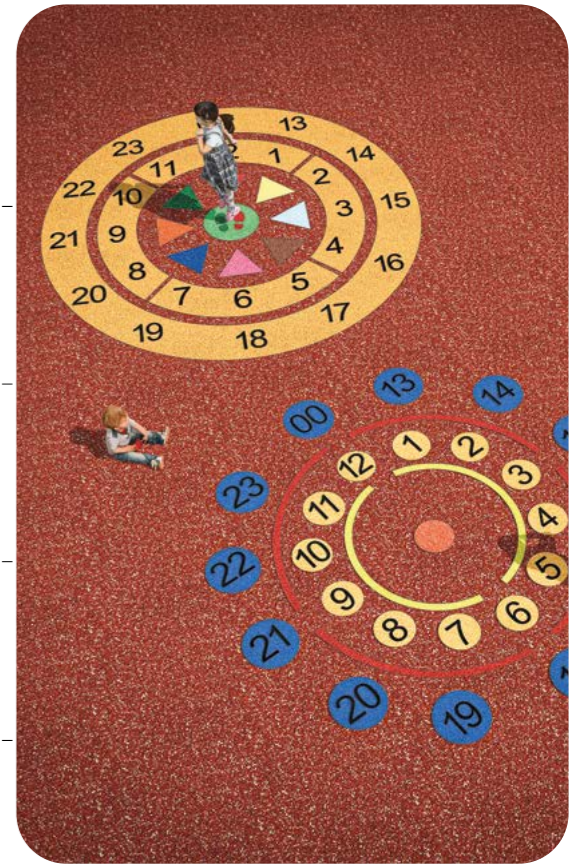

Flower-2
100x100 cm
D2-01A-09



Flower-7 MINI
18x18 cm
D2-05A-52UV



Flower-5
100x100 cm
D2-02A-03

Flower-8 - malá
55x55 cm
D2-04A-54UV



Set of TULIPS
190x265 cm
D2-03A-70UV





Stones with letters - 26 pcs
50 cm
D4-06A-05



Stones with numbers 1-10
50 cm
D4-07A-00



Stones - 1 pc
47x38 cm
D4-03A-00

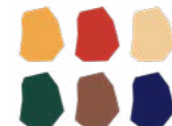

Stone with letter
50 cm
D4-04Z-50UV



Mushroom-1
70x95 cm
D3-01A-02



Pear
70x105 cm
D3-02A-52UV



Apple
85x95 cm
D3-03A-09



Pumpkin
90x80 cm
D3-04A-59UV



Rainbow
150x60 cm
D5-02A-70UV



Sun-2
100x100 cm
D5-01A-03



Moon
71x105 cm
D5-03A-52UV



Fire - big
115x80 cm
D5-05A-03
Fire - small
35x25 cm
D5-05B-03



Cloud
105x75 cm
D5-04A-06



**BE CREATIVE!
DO COMBINATION
OF GRAPHIC
ELEMENTS.**

**USE 4SOFT SPORTS
AND JUMPING
GRAPHICS TO
CREATE A NEW
GAMES.**



2D GAMES & FITNESS

START - FINISH
80x55 cm
E1-03A-02

**FINISH
START**

Labyrinth
Ø240 cm
E1-01A-20



Sign: START
17x75 cm
E1-03C-02

START

Long jump (0-300)
150x380 cm
E1-02B-21



Long jump (50-200)
245x80 cm
E1-02A-71UV



Target with numbers 1, 5, 10
Ø120 cm
E1-04A-57UV



Target with numbers - big
Ø215 cm
E1-05A-20

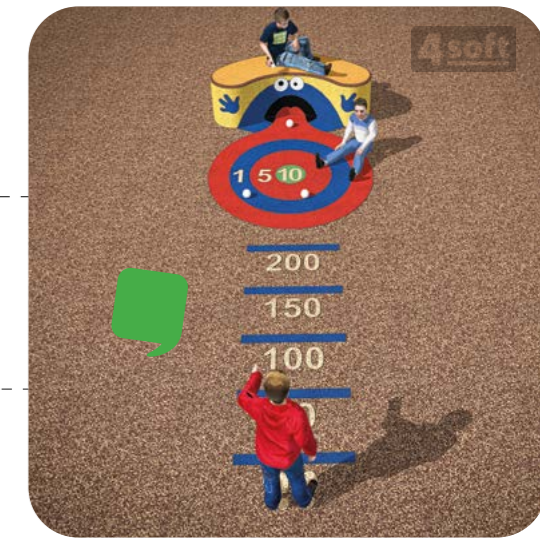

Long jump with animals I.
195x90 cm
E1-06A-20



Clock
Ø240 cm
E2-01A-03

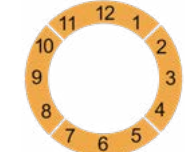

Hopscotch snail 1-16 - BIG
255 cm
E2-02A-20



Hopscotch snail 1-8 - SMALL
175x155 cm
E2-02B-20



Hopscotch Beads
430x200 cm
E2-03A-20



Hopscotch Kite (1-9)
680x145 cm
E2-04A-20

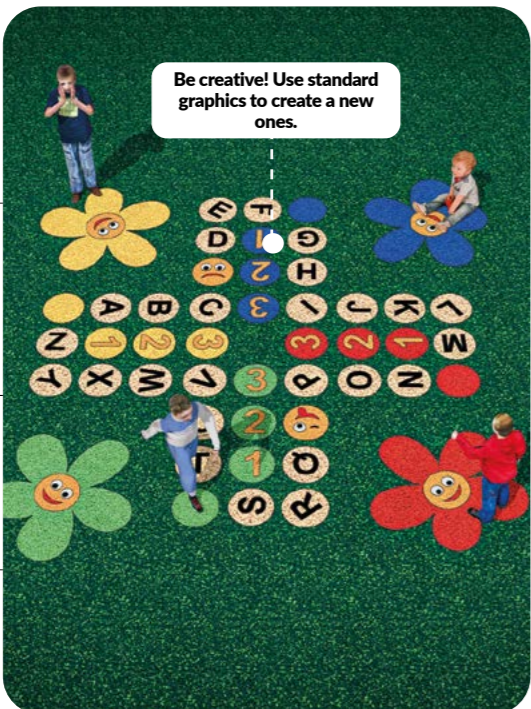

Ludo BIG (set of 60 pcs)
370x370 cm
E3-01A-00



Ludo - Small (set of 60 pcs)
230x230 cm
E3-01B-00



Hopscotch set 4 x SQUARES (41 pcs)
525x525 cm
E3-03A-00

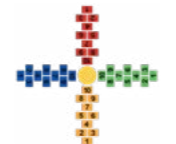

Jump mirror with circles 18 cm
255x113 cm
E3-04C-20



Jump mirror with circles 18 cm (Quatro)
350x272 cm
E3-04F-00



Jump mirror with stars
310x150 cm
E3-04H-20



Hopscotch Alien
255x84 cm
F2-01A-53UV

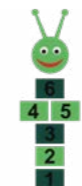

Waterman
295x180 cm
F3-07A-20



Hopscotch Fairy
250x180 cm
F3-04A-20



Hopscotch Castle with letters
370x390 cm
F3-01A-00



Hopscotch Palace with letters
450x380 cm
F3-01C-20



Hopscotch Tower 1-6
215x100 cm
F3-02B-20

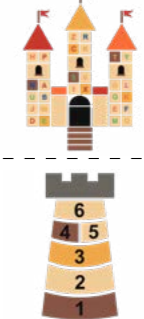

Hopscotch Dragon A
250x480 cm
F3-03A-59UV



Hopscotch Dragon B
550x350 cm
F3-03B-53UV

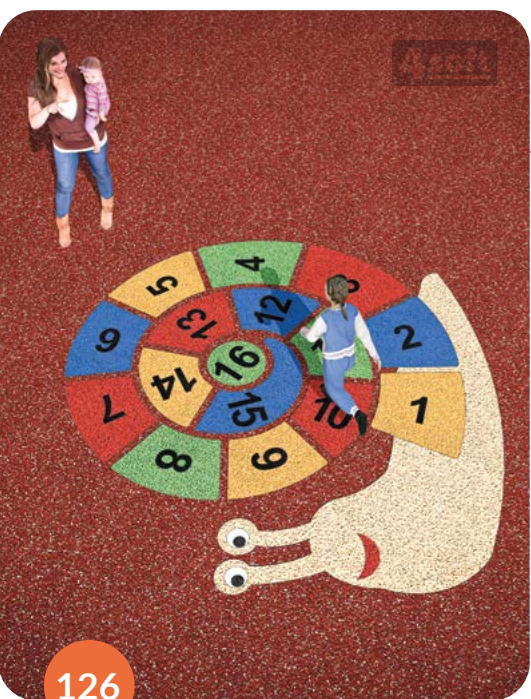
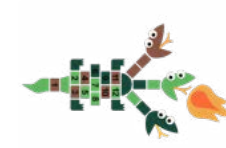

Twister - small (set of 24 pcs)
140x110 cm
E3-02A-00



Twister - big (set of 24 pcs)
200x135 cm
E3-02B-00



Twister geometric shapes
140x108 cm
E3-02C-00

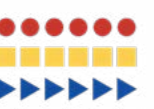

Compass - 2D
160x160 cm
E2-05A-20

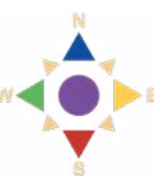

Snake & Ladders game
900x370 cm
E3-05A-53UV



Jump mirror Animals
297x125 cm
E3-04B-20



Hopscotch Small-boy 1
250x85 cm
F1-03A-00



Hopscotch Small-girl 1
250x85 cm
F1-04A-00

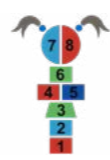

Hopscotch squares 1-10
220x85 cm
F1-02A-00



Hopscotch squares Roman numbers I-X
220x85 cm
F1-02B-53UV

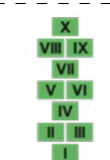

Hopscotch Big-boy
300x135 cm
F1-01A-00

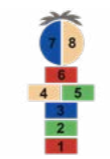

Hopscotch Different shapes (1-10)
250x70 cm
F1-05A-20



Hopscotch Different shapes I-VII
250x70 cm
F1-05B-20



Hopscotch astronaut
255x150 cm
F2-02C-59UV



Hopscotch Space rocket
340x140 cm
F2-03A-20



Hopscotch Spaceship (1-5)
220x95 cm
F2-04A-20



Hopscotch Princess
250x180 cm
F3-05A-20

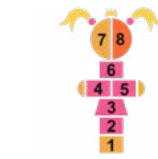

Hopscotch knight A
245x195 cm
F3-06A-20

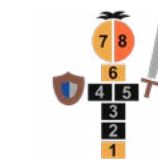

Hopscotch knight B
295x210 cm
F3-06B-20



Hopscotch Fireman 1
220 x 85 cm
F4-01A-20



Snake 2 with numbers
520 cm
F5-02A-53



Caterpillar Small with numbers 1-10
400 cm
F6-01B-57UV



Lighthouse with numbers
210x240 cm
F7-01A-20



Ambulance
140x100 cm
G1-03A-55UV



STOP signal
90x90 cm
G2-02A-09

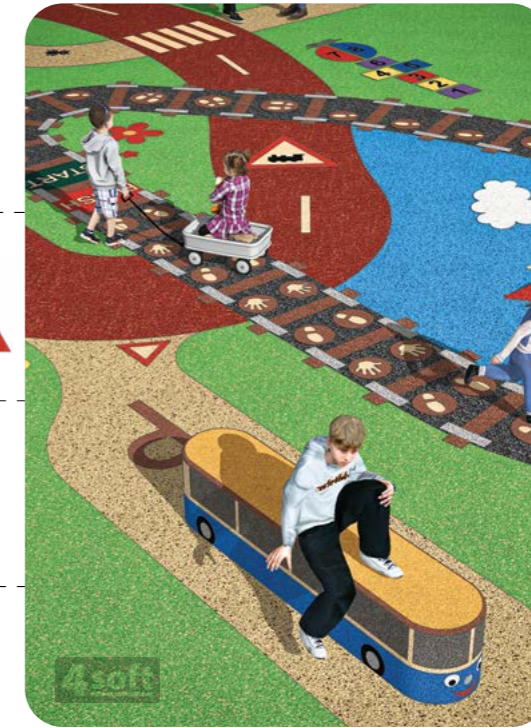

No Parking sign
Ø40 cm
G2-23A-57UV



Hopscotch Fireman 3
240 x 85 cm
F4-01C-20



Caterpillar Big with alphabet A-Z
500x250 cm
F6-01C-20



Jump pointed Tower (1-9)
220x74 cm
F7-02A-20



Ambulance
140x100 cm
G1-03A-55UV



Turn left triangle
40x40x40 cm
G2-24A-09



Turn right triangle
40x40x40 cm
G2-24B-09



Danger animals triangle signal
100x100x100 cm
G2-04A-02



Bumpy road sign
40x40x40 cm
G2-27A-09



Right of way signal
G2-16A-09



Striping right of way
G2-15A-02



Caution train signal
100x100x100 cm
G2-33A-09



Way direction sign
Ø40 cm
G2-21A-57UV



Traffic roundabout
Ø40 cm
G2-30A-57UV



Petrol station
100x100 cm
G2-05A-57UV



Cafeteria announcement signal
100x100 cm
G2-06A-57UV



Hopscotch Diver
230 x 110 cm
F4-02A-20

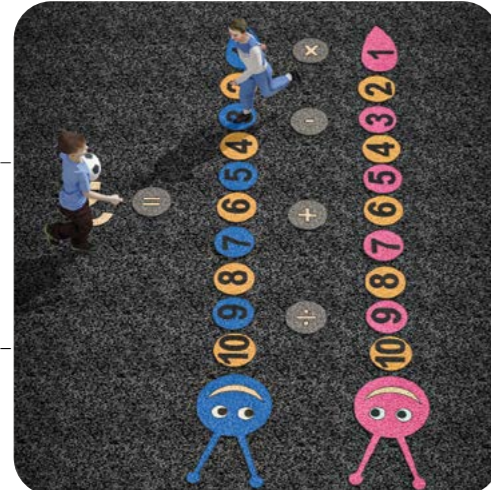
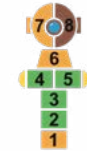

Hopscotch - Crocodile (1-10)
400x160 cm
F6-02A-53UV



2D TRAFFIC



Tractor with trailer (12 pcs)
175x350 cm
G1-01A-20



2D and 3D graphics can be used in many great ways. Create your original playground.



Fire truck
140x100 cm
G1-04A-09



Police car
140x100 cm
G1-05A-06



Lights BIG
45x110 cm
G2-01B-07



Lights SMALL
30x85 cm
G2-01A-58UV

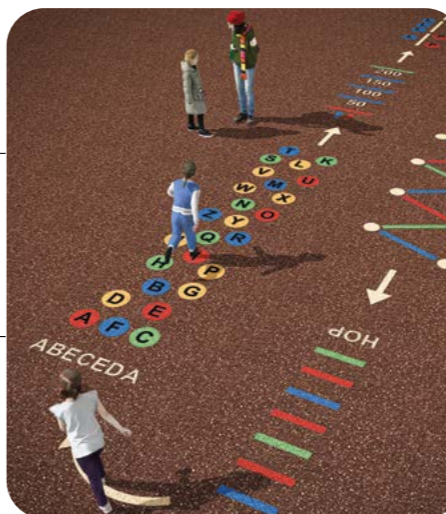

No entry sign
Ø40 cm
G2-31A-09



Speed limit
Ø40 cm
G2-32A-02



No entry sign
Ø40 cm
G2-28A-02



Picnic area announcement signal
100x100 cm
G2-07A-57UV



Striping Parking
70x90 cm
G2-26A-57UV
Striping - letter P parking
80x46 cm
G2-11A-02



Highway sign
35x35 cm
G2-17A-52UV



Hopscotch Railway dispatcher
250x85 cm
F4-04A-20



Jump leaflets with numbers
300x220 cm
F5-03B-20



Bubbles 30 cm with numbers
Ø30 cm
F5-01A-06



Locomotive & wagon (10 pcs)
260x150 cm
G1-02A-20

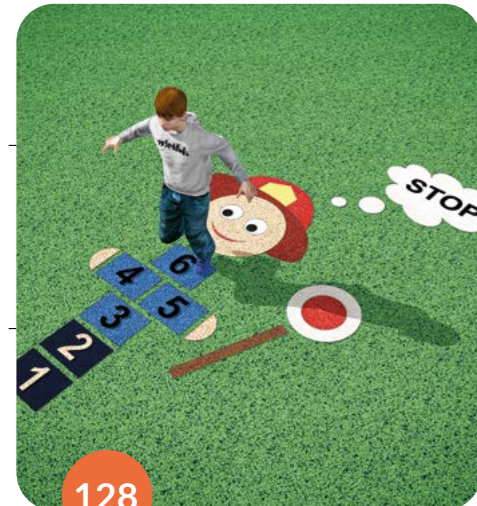

Jump side to side
285x85 cm
F5-05B-20

Jump side to side with footprints
520x90 cm
F5-04A-20

Sunflower hopscotch
730x230 cm
F5-06A-20





Striping 180°
85x55 cm
G2-25A-02



Dashes 1 pc
80x8 cm
G2-10A-02



Petrol station (set of 2 pcs)
60x80 cm
G2-08A-02



Striping - Curve
109x28 cm
G2-29A-02



Striping - street line L
100x57 cm
G2-22A-02



Fire hose nozzle
48x27 cm
G3-02A-58UV



Hydrant
105x60 cm
G3-03A-09



Railway sleeper
100x35 cm
G3-04A-05



Submarine - 1
120x55 cm
G4-01A-03

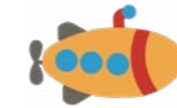

2D SIMPLE PICTURES

H1-06C-03 Emoji smile Ø30
H1-06A-03 Emoji smile Ø50
H1-06B-03 Emoji smile Ø100



H1-02C-03 Emoji angry Ø30
H1-02A-03 Emoji angry Ø50
H1-02B-03 Emoji angry Ø100



H1-03C-03 Emoji nictate Ø30
H1-03A-03 Emoji nictate Ø50
H1-03B-03 Emoji nictate Ø100



H1-04C-03 Emoji screaming Ø30
H1-04A-03 Emoji screaming Ø50
H1-04B-03 Emoji screaming Ø100



H1-05C-03 Emoji crying Ø30 cm
H1-05A-03 Emoji crying Ø50 cm
H1-05B-03 Emoji crying Ø100 cm



H1-06C-03 Emoji tongue Ø30 cm
H1-06A-03 Emoji tongue Ø50 cm
H1-06B-03 Emoji tongue Ø100



Splash - SMALL
H2-01B-06



Splash with 3 drops
H2-01A-57UV

H3-01C-56UV Drop 26 cm
H3-01B-06 Drop 40 cm
H3-01A-61UV Drop 56 cm



Arrow
120x39 cm
H4-01A-05



Ghost
105x95 cm
H4-05A-55UV



Hunted house
90x115 cm
H4-06A-58UV



Meteorites (set of 3 pcs)
2x(35x25 cm)
1x(115x85 cm)
H5-01A-03



Solar system planets (11 pcs)
3x Ø40, 2x Ø60
.1x Ø10, 1x Ø90,
2x Ø7cm
H5-02A-70UV

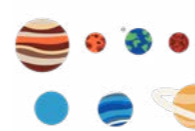

LETTERS & NUMBERS

Letter A-Z (1 pc)
17 cm
I2-01Z-00



Letters A-Z set of 26 letters
17 cm
I2-02A-50UV

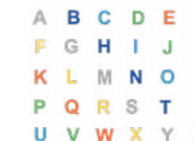

Small letter a-z (1 pc)
17 cm
I2-04Z-00



Number 0 - 9 (1pc)
21 cm
I1-01Z-00



Number 0-9 size - 45 cm (1pc)
I1-03Z-50UV



Math symbols set (6pcs)
15x15cm (1pc)
I4-01A-07



Note - 1 - black
30 cm
I5-01A-07



Note - 2 - black
35 x 20 cm
I5-01B-07



Note - 3 - black
30 x 8 cm
I5-01C-07



Violin key black
50 x 25 cm
I5-01D-07



Comma
I3-01B-07
Degree symbol
I3-01C-07
Wedge
I3-01A-07



Arrow - turn right
75x44 cm
G2-12B-02
Arrow turn left
75x44 cm
G2-12C-02



Striping - Arrow straight + right
G2-13B-02
Striping - Arrow straight + left
G2-13A-02



Striping - Round Arrow - right
G2-12D-02
Striping - Round Arrow - left
G2-12C-02

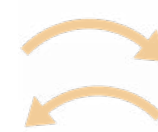

Striping straight Arrow
G2-14A-02

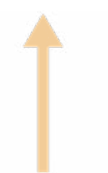

Life buoy
Ø100 cm
G3-01A-09



Target stand with 3 arrows
120x220 cm
H4-01B-70UV

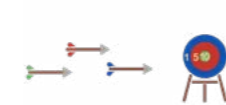

2D Winners Podium
150x50 cm
H4-02A-52UV



Flag - small
240x100 cm
H4-03A-70UV





3D SPORTS & GAMES

3D Crocodile BIG (2D body with numbers)
620x270 cm
J1-01A-20



3D Compass (set of 13 pcs)
230x230 cm
J2-01A-06



3D Rubik's cube SMALL
80x80 cm
J2-02A-20



3D Rubik's cube BIG
120x120 cm
J2-02B-20

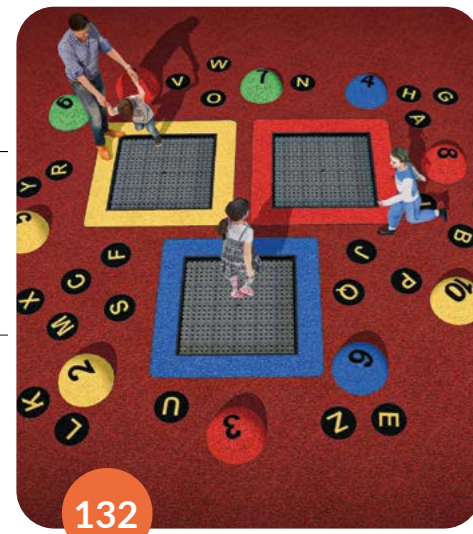

3D Palm tree
420x360 cm
J2-03A-05



LUDO big 3D - circle
Ø490 cm
J3-01A-20

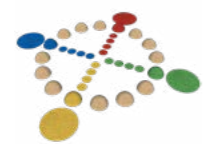

LUDO big 3D - square
585x585 cm
J3-02A-20



3D ANIMALS

3D Turtle
115x130 cm
K1-01A-05



3D Sea star
110x110 cm
K1-02A-09



3D Head of crocodile
120x75 cm
K1-03A-04



3D Whale
270x135 cm
K1-04A-11



3D Shark
136x83 cm
K1-06A-61UV



3D Crocodile half balls
600x260 cm
K1-07A-20



3D Octopus
295x295 cm
K1-08B-52UV



3D Frog
100x130 cm
výška 50 cm
K1-10A-70UV



3D Carp
180x160x100 cm
K1-11A-20



3D Snake (5pc)
460 cm
K2-01A-20



3D Crocodile with numbers
500x210 cm
K1-07D-20



3D Dolphin
220x140x33 cm
K1-09A-61UV



3D Miss Hippo
115x85 cm
K1-05A-61UV



3D Lizard
500x210 cm
K4-01A-20



3D Spider
120x80 cm
K2-02C-07



3D Caterpillar
500 cm
K5-02D-70UV



3D Head of caterpillar
105x70 cm
K5-02B-03



3D Camel
250x150 cm
K4-02A-20



3D Dragon
K4-03A-53UV



3D Ladybird "PLAY"
1150x120 cm
K5-01B-01



3D Caterpillar (SET with numbers 1-10)
800 cm
K5-02C-70UV



3D Butterfly - 2D wings
300x240 cm
K5-03A-57UV



3D Bee
130x160x30 cm
K5-04A-52UV



3D NATURE

3D Stone (1 pc)
55x55x13 cm
L1-01K-05



3D Stone with number 0-10 (1pc)
55x55x13 cm
L1-01Z-50UV

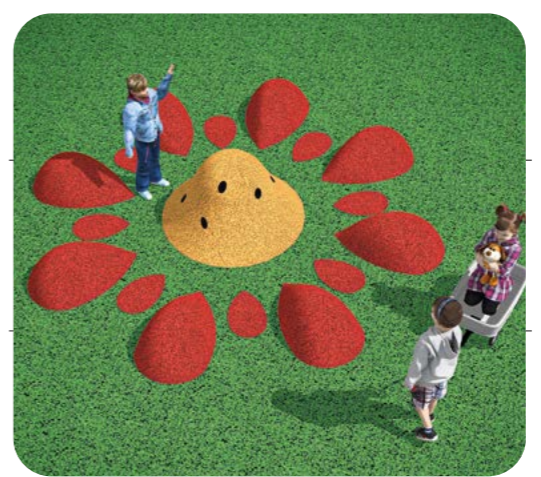

3D Stone with letter A-Z
55x55x13 cm
L1-04Z-00



Set of 3D Stones with letter A-Z (26 pcs)
L1-05A-50UV



3D Flower
240x240 cm
L5-01A-70UV



3D Cloud
130x90 cm
L2-02A-57UV



3D SHAPES

M1-01A-09 EPDM Seater
M1-01B-03 1 colour,
height:
M1-01C-01 30/40/50cm



M1-02A-52UV Seater with graphics
M1-02B-57UV height:
M1-02C-53UV 30/40/50



Metal anchor with plate
(fixing into the concrete)
O2-01A-00



Metal anchor - pipe
(fixing into the concrete)
O2-01B-00
Anchor - pipe short
(fixing into the concrete)
O2-02B-00



3D Winners Podium
Ø40 cm
M1-03A-01



CUBE with Graphics (5 sides)
40x40x40 cm
M2-03A-20



3D CUBE workout (5 sides)
40x40x40 cm
M2-03A-21



3D CUBE 1 colour (1pc)
40x40x40 cm
M2-01A-00



3D Hemisphere one colour (1pc)
1 colour, Ø 30cm
M3-08A-00
1 colour, Ø 50cm
M3-03A-50UV
1 colour, Ø 75cm
M3-07A-00



3D Hemisphere with graphics (1pc)
Ø 30cm
M3-09Z-50UV
Ø 50cm
M3-05A-50UV



3D Half ball - Football design
Ø75 cm
M3-04A-20
Ø100 cm
M3-04B-20



Earth East hemisphere
M3-06A-70UV
Earth West hemisphere
M3-06B-70UV



3D EPDM hill height 60 cm
M4-01A-50UV



3D Emoticon - YES
M3-01A-03



3D Emoticon - NO
M3-01B-03

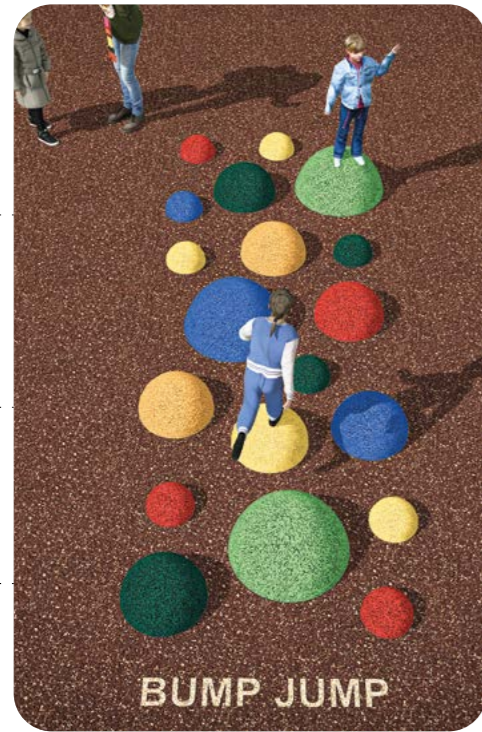

BUMP JUMP



3D FOUNTAINS
A water nozzle can be installed into any 3D shape according to your requirements.

Head of crocodile with fountain
120 x 75 cm
W1-01A-04



3D Whale with fountain
270 x 135 cm
W1-02A-11



Miss Hippo with fountain
270 x 135 cm
W1-03A-61UV



Elephant with fountain
210 x 270 cm
W1-04A-65UV
W1-04B-65UV



3D Hill with fountain
Ø100 cm,
h. 50 cm
W1-05A-50UV



3D Globe with fountain
Ø 100 cm,
h. 50 cm
W1-05B-70UV



3D Camel with fountain
250 x 150 cm
W1-06A-20



3D Palm tree with fountain
420 x 360 cm
W1-07A-05



3D See Star with fountain
110 x 110 cm
W1-08A-09



Dolphin with fountain
280 x 120 x 33 cm
W1-09A-61UV



3D turtle with fountain
115 x 130 cm,
h.32 cm
W1-10A-05



3D Frog with fountain
W1-13A-70UV



3D Cloud with fountain
W1-15A-50UV



3D Ball with fountain
Ø75 cm
W1-11A-20



3D Carp with fountain
180 x 160 cm,
h.50 cm
W1-12A-20



Splash shower 4-flowers
W2-01A-09
Splash shower 3-flowers
W2-01B-00



Ladybird with fountain
W1-14A-01



TUNNELS & SLIDES

3D Octopus tunnel
360 x 360 cm,
h. 80 cm
T1-05A-52UV



MINI Tunnel Anthill
Ø120 cm
T1-02A-20



MINI Tunnel Coral reef
Ø120 cm
T1-03A-70UV

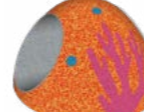

MINI Tunnel (1pc)
Ø120 cm
T1-01A-00



3D Ladybird with tunnel
135 x 180 cm,
h. 80 cm
T1-04A-01



Tunnel 1
T2-01A
Tunnel 2
T2-01B
Tunnel 3
T2-01C



Tunnel 4
T2-02A

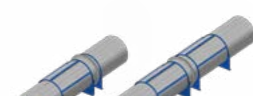

Tunnel 5
T2-02E



Tunnel Curve SMALL
T2-02D



Tunnel Curve
T2-02H

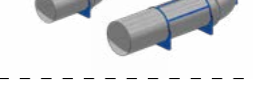

3-EXIT Tunnel SMALL
T2-02B

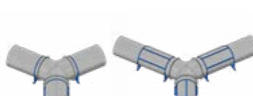

3-EXIT Tunnel
T2-02F



4-EXIT Tunnel SMALL
T2-02C



4-EXIT Tunnel
T2-02G



FunPipe SMART Long
T3-01A-FPL



FunPipe SMART Small
T3-01B-FPS

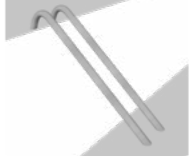

Slide TS 510
T3-02A



Slide TS 515
T3-02B



Slide TS 1010
T3-03A



Slide TS 1015
T3-03B



Slide TS 520
T3-02C

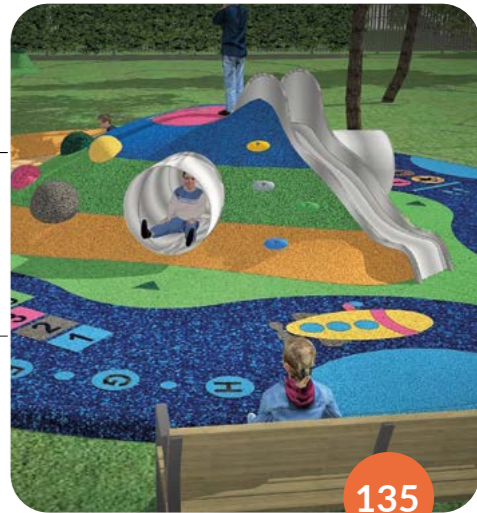



3D HOUSES

Mushroom's house

Ø 220 cm
P1-01A-20



Space modul

Ø 220 cm
P1-02A-20



EPDM house different designs

Ø 220 cm
P1-03A-00



Tip of the submarine

Ø 220 cm
P1-04A-20

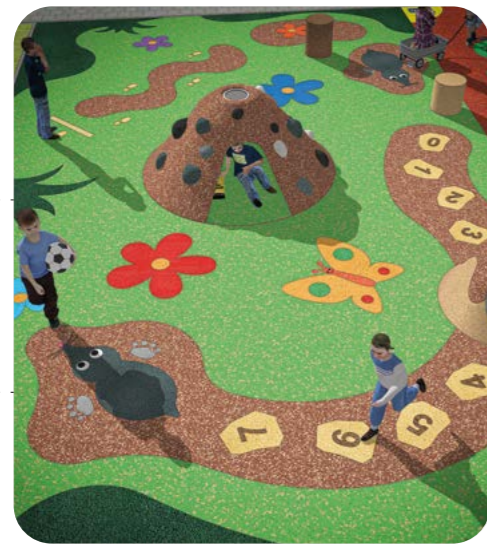

3D Bench cluster - Butterfly
260 x 265cm,
h.46cm
V1-05B-70UV



3D Bench - cluster Benchozilla
125 x 430cm, h.50cm
V1-06A-70UV



3D Bench - cluster Benchosaurus
125 x 430cm, h.50cm
V1-06B-70UV



3D Bench PLAY Dragonfly
515 x 510cm, h. 46cm
V1-08A-70UV



3D Bench PLAY Caterpillar
175 x 630cm, h.46cm
V1-07A-70UV

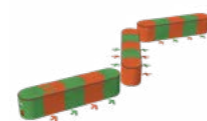

FURNITURE

3D Bench PLAY DIRECT
220x46x46 cm
V1-01A-50UV



3D Bench PLAY BOW
180x64x46 cm
V1-01B-50UV



3D Bench PLAY DIRECT
180x46x46 cm
V1-01C-50UV



Bench PLAY Cluster - Spider
250x260cm, h.46cm
V1-05A-70UV



Humpy-Bumpy BIG
Ø50cm, h.25cm
V3-01B-00

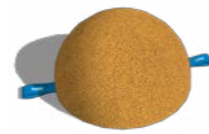

Humpy-Bumpy SMALL
Ø30cm, h.15cm
V3-01A-50UV



Humpy-Bumpy 50 Ladybird
Ø50cm, h.25cm
V3-02B-70UV



Humpy-Bumpy 50 Turtle
Ø50cm, h.25cm
V3-03B-70UV



Humpy-Bumpy 30 Bunny
Ø30cm, h.15cm
V3-04A-70UV



Humpy-Bumpy seater 1
one colour
V4-01A-00



Humpy-Bumpy seater 2
without graphics
V4-01A-50UV



Humpy-Bumpy seater 3
with top and side graphics
V4-04A-50UV

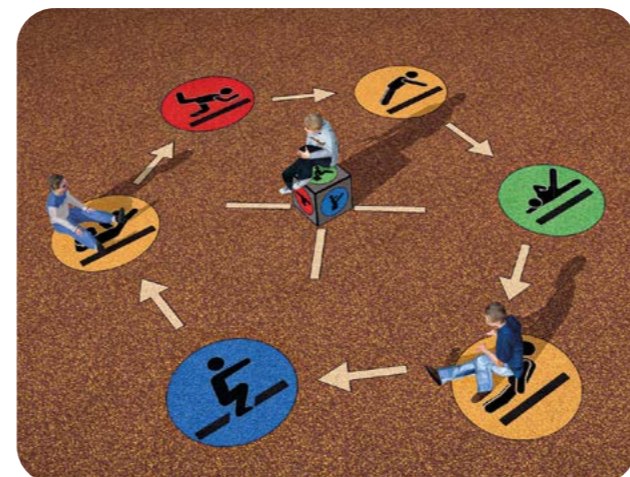
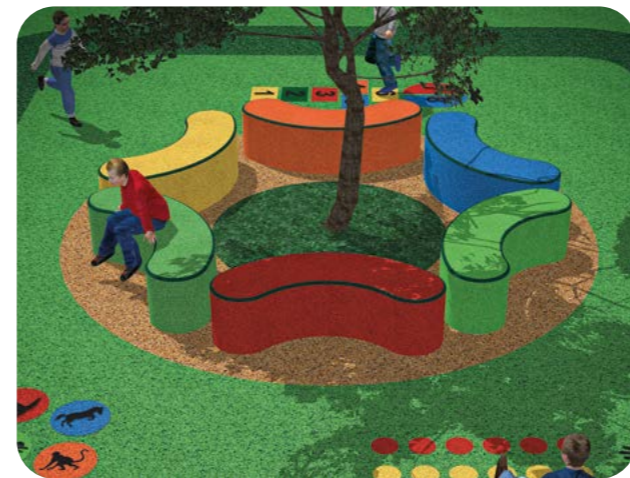

4SOFT CAN HELP YOU DESIGN YOUR REQUIRED PLACE.

For more inspiration CHECK OUT www.epdm-graphics.com

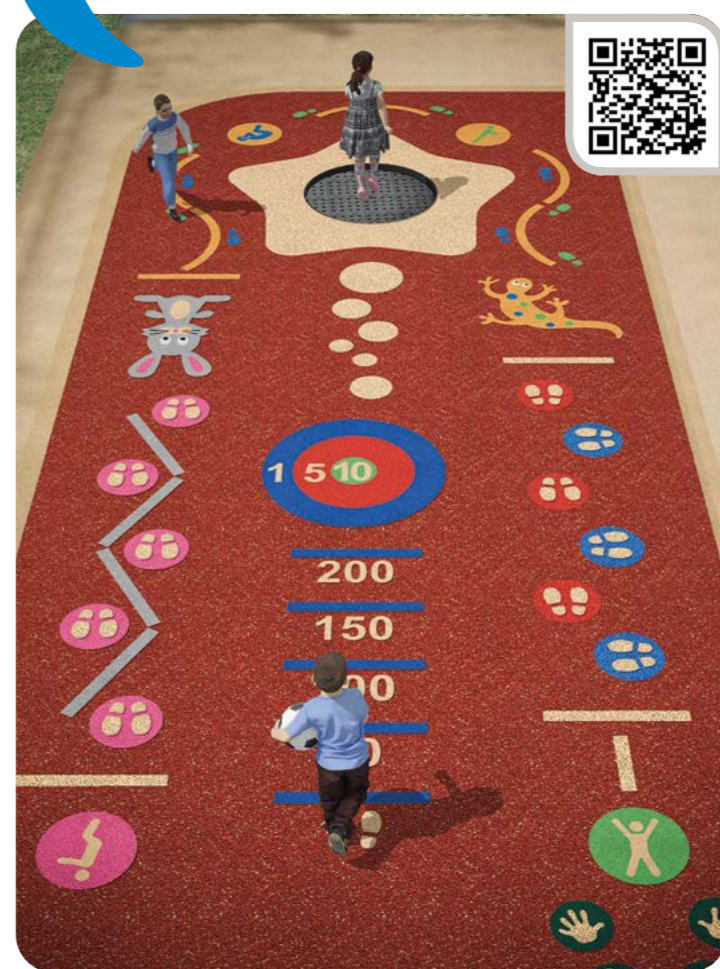



BEWARE OF LOW-QUALITY IMITATIONS!

These kinds of pictures are not Durable, the paint wears off after a year or two and the picture disappears.

Request only graphical features made from coloured EPDM granules, which retain their colour for the whole lifespan of the surface even in extremely stressed areas.

ATTENTION!
CERTAIN SUPPLIERS
MAKE GRAPHIC ELEMENTS
ONLY BY SIMPLY PAINTING
OR SPRAYING THE SURFACE.

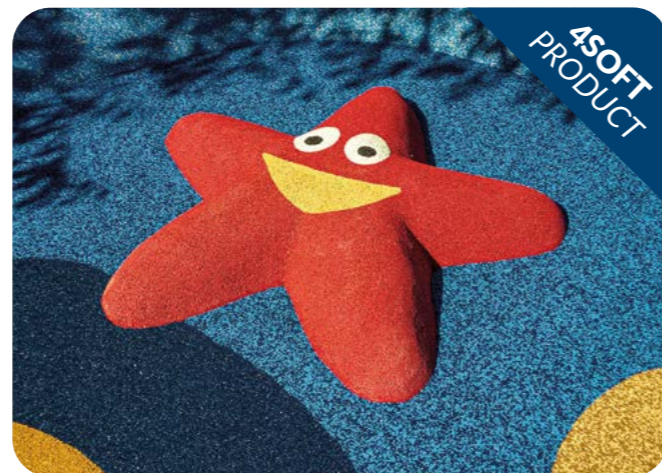
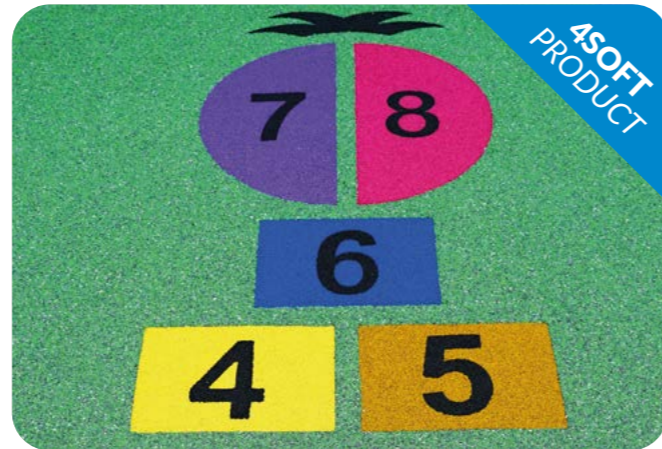

PACKING OF THE GRAPHIC COMPONENTS

FAST EASY CHEAP PERFECT

We always try to find the most effective and cheapest solution for packing and transporting our products to customers.

Each consignment is calculated separately according to its weight, dimensions and place of delivery.

It is always more effective to ship more components in one load.



BASIC COLOURS OF COMPONENTS:

SAMPLE COLOURS

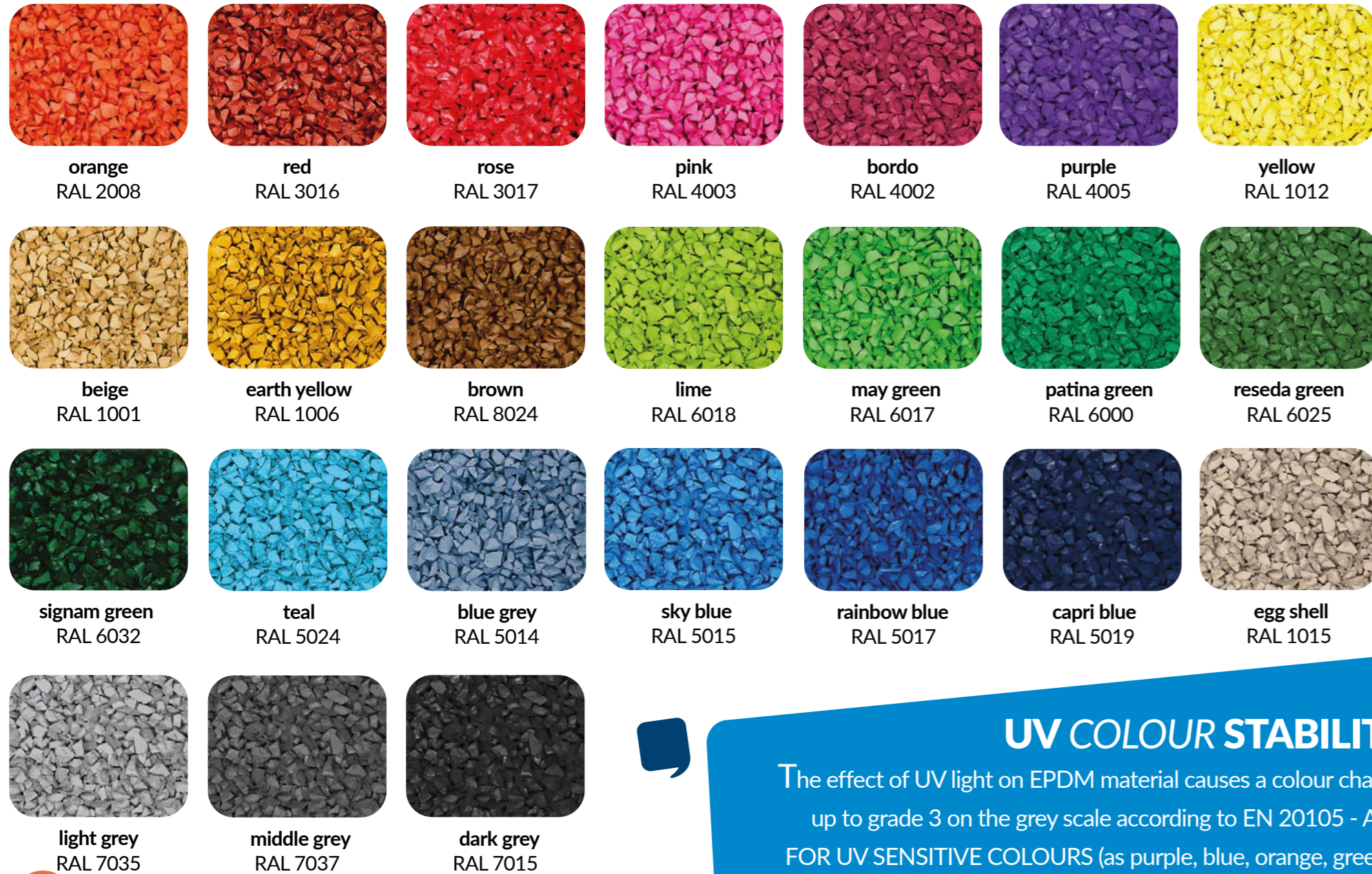

CHOOSE THE RIGHT GRAPHIC COMPONENTS & GLUE THEM

UV COLOUR STABILITY

The effect of UV light on EPDM material causes a colour change up to grade 3 on the grey scale according to EN 20105 - A02.
FOR UV SENSITIVE COLOURS (as purple, blue, orange, green...) we use aliphatic UV lightstable binder!

EPDM-GRAPHICS.COM
ONE SURFACE, MANY OPTIONS

CONTACT US:

Safefloor ApS

Bjødstrupvej 10

8410 Rønde

Danmark

Phone: +45 8615 1925

E-mail: info@safefloor.dk